

BEKASIA

ELEVATOR | PVC | CONSTRUCTION
BATHROOM ACCESSORIES | STEEL DOOR | DECORATION
M A T E R I A L S

İM O D E R N Y E N İ L İ K Ç İ



2021

Catalogue / Katalođu

Güvenliđiniz Emin Ellerde...

BEKASIA
E L E V A T O R

*daima yenilik ve daima gelişim
göstermek için, sürekli gayret
veriyoruz.*

"Çünkü; güvenliğiniz bizim elimizde."



Hakkımızda / About US

Asansör İmalatı , paket asansör sistemleri ve elektroniğinde “dizayn, üretim, teknik destek, satış sonrası hizmet, danışmanlık, satış, ithalat ve ihracat konularında faaliyet gösteren şirketimiz, BekAsia markası altında aranan ve güvenilen bir marka haline gelmekte ve dikey kentleşmenin en önemli unsurlarından biri olan asansör sektöründe yılların tecrübesini siz müşterilerimize sunmaktadır.

BekAsia, günümüz ve geleceğin modern toplumunun ihtiyaç duyduğu ortak özelliklerin tümünü kendi bünyesinde toplamaktadır. Ürünlerimizin her biri; emniyet, güvenilirlik, performans, konfor, fonksiyonellik ve ergonomik gereksinimlere dayanan tasarım ve imatlardan oluşmaktadır. Gelişen teknolojiyi takip eden, kaynaklarını etkin kullanabilen ve gelişime açık müşteri memnuniyeti çerçevesinde ürünler sunan firmamız, toplumun değişen gereksinimlerini karşılama politikasının bir sonucu olarak insanların refahına ve ülke ekonomisine pozitif katkılarda bulunmayı hedef alır.

Bir ürünün toplam kalitesi, o ürünün imalatında kullanılan malzeme ve komponentlerin ayrı ayrı sahip olduğu kalite değerlerinin toplamıdır. Bundan dolayı ürünlerimizde ilgili yönetmelik ve standartlara uygun ve sürekli olarak test, muayene ve kontrol prosedürlerine tabi tutulan kaliteli malzeme ve komponentleri kullanmaktayız. Firmamızın dayandığı bu felsefe, ürünlerimizin her birine üstün kalite damgasının vurulmasının bir güvencesidir.

Firmamız için “kalite” sadece ulaşılan ve korunan bir düzey değil, koşullara göre iyileştirilen, geliştirilen ve yenilenen bir hedeftir. Tüm firma çalışanlarının paylaştığı bir sorumluluktur.

Kalite ve güven firmamızın geleceğinin teminatıdır. Firma olarak en temel prensibimiz; işimize bağlılık, konumuzda profesyonellik, toplam kalite yönetimi, kurumsal organizasyon yapısı ve nihai müşteri memnuniyeti ve sürekliliğin temini ve tesisidir.

Operating in the fields of "design, production, technical support, after-sales service, consultancy, sales, import and export in elevator manufacturing, package elevator systems and electronics, our company becomes a sought-after and trusted brand under the BekAsia brand and is one of the most important elements of vertical urbanization. offers years of experience in the elevator industry to our customers.

BekAsia gathers all the common features required by today's and future's modern society. Each of our products; It consists of designs and manufacturing based on safety, reliability, performance, comfort, functionality and ergonomic requirements. Our company, which follows the developing technology, can use its resources effectively and offers products within the framework of customer satisfaction open to improvement, aims to make positive contributions to the welfare of people and the country's economy as a result of its policy to meet the changing needs of the society.

The total quality of a product is the sum of the individual quality values of the materials and components used in the manufacture of that product. Therefore, we use quality materials and components in our products that are constantly subjected to testing, inspection and control procedures in accordance with the relevant regulations and standards. This philosophy that our company is based on is a guarantee of the superior quality of each of our products.

For our company, "quality" is not only a level reached and maintained, but a target that is improved, developed and renewed according to the conditions. It is a responsibility shared by all company employees.

Quality and trust is the guarantee of the future of our company. Our most basic principle as a company; Dependence on our business, professionalism in our subject, total quality management, corporate organizational structure and the provision and establishment of final customer satisfaction and continuity.



BEKASIA
E L E V A T O R

KABİN KAPILARI

CABINS DOOR

Kabin Kapısı

Premium Series
VTO2P

Cabin Door / Porte Cabine
Дверь кабины / باب المصعد

Kabin Kapısı



Teleskopik 2 Panel Kabin Kapısı

Telescopic 2 Panel Cabin Door

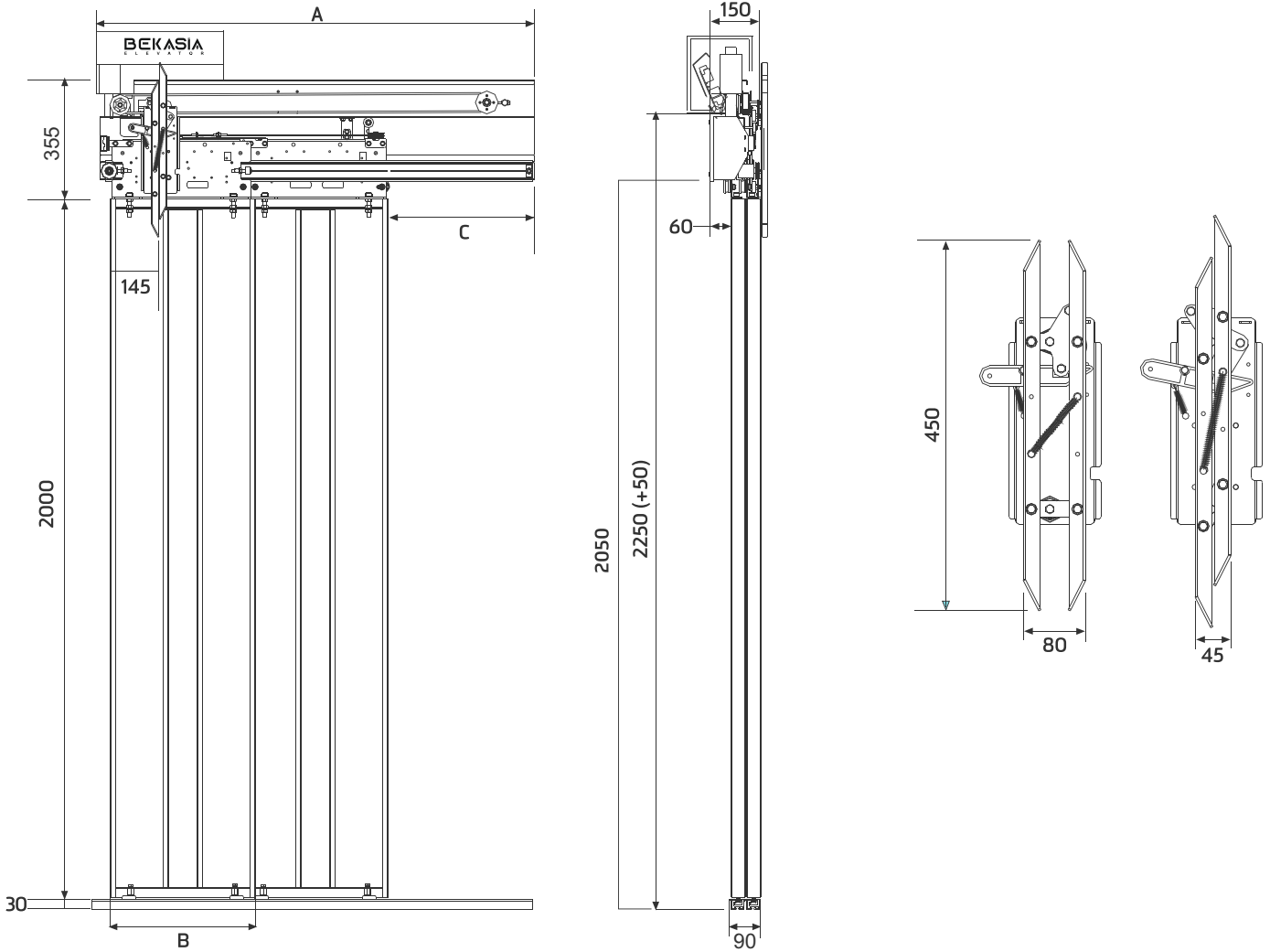

ÖLÇÜLER/DIMENSIONS/DIMENSION/ размеры / أبعاد

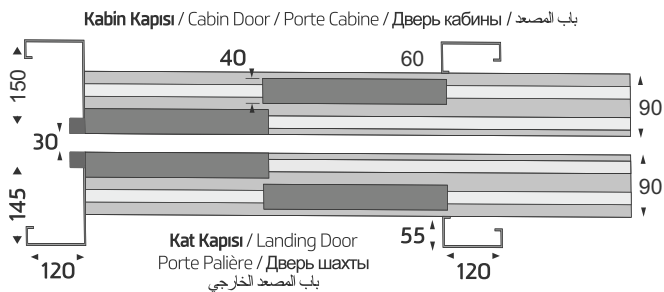

ÖLÇÜLER/DIMENSIONS/DIMENSION/ размеры / أبعاد

PL (mm)	A (mm)	B (mm)	C (mm)
700	1100	370	380
800	1250	420	430
900	1400	470	480
1000	1550	520	530
1100	1700	570	580
1200	1850	620	630
1300	2000	670	680
1400	2150	720	730
1500	2300	770	780
1600	2450	820	830

Kabin Kapısı

Premium Series
VTO3P

Cabin Door / Porte Cabine
Дверь кабины / باب المصعد

Kabin Kapısı



Teleskopik 3 Panel Kabin Kapısı

Telescopic 3 Panel Cabin Door

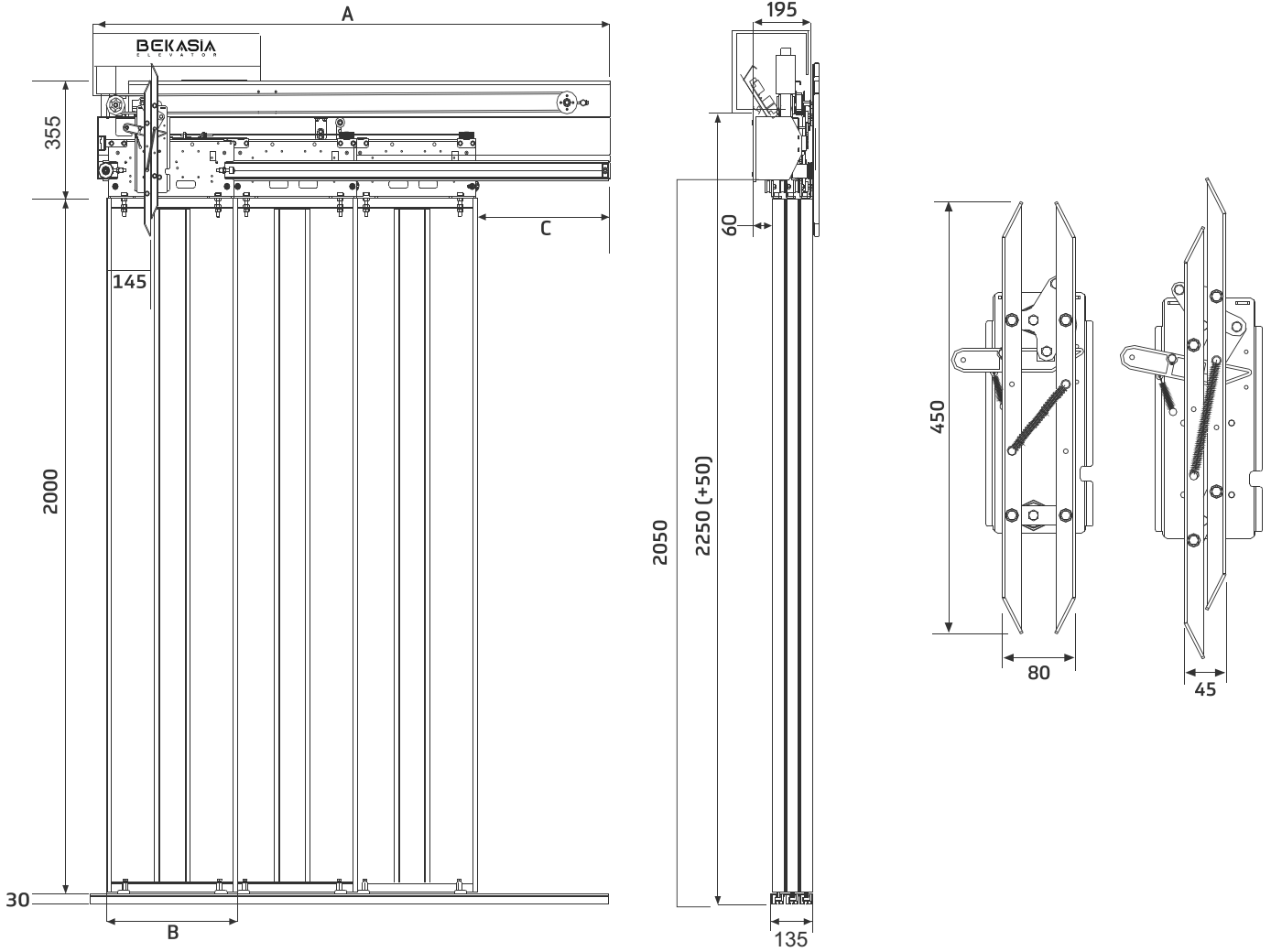

ÖLÇÜLER/DIMENSIONS/DIMENSION/ размеры / أبعاد

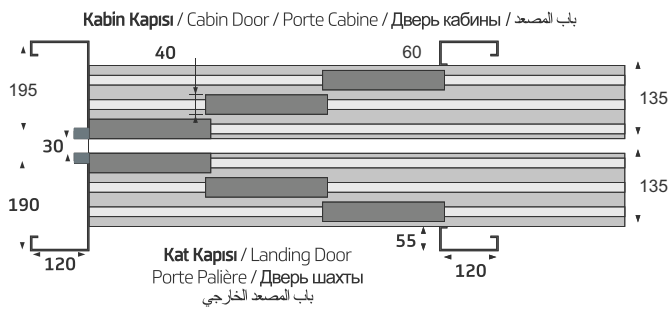

ÖLÇÜLER/DIMENSIONS/DIMENSION/ размеры / أبعاد

PL (mm)	A (mm)	B (mm)	C (mm)
800	1117	287	297
900	1250	320	330
1000	1383	353	363
1100	1517	387	397
1200	1650	420	430
1300	1783	453	463
1400	1917	487	497
1500	2050	521	531
1600	2183	554	564

Kabin Kapısı

Premium Series
VCO2P

Cabin Door / Porte Cabine
Дверь кабины / باب المصعد

Kabin Kapısı



Merkezi 2 Panel Kabin Kapısı

Central Opening 2 Panel Cabin Door

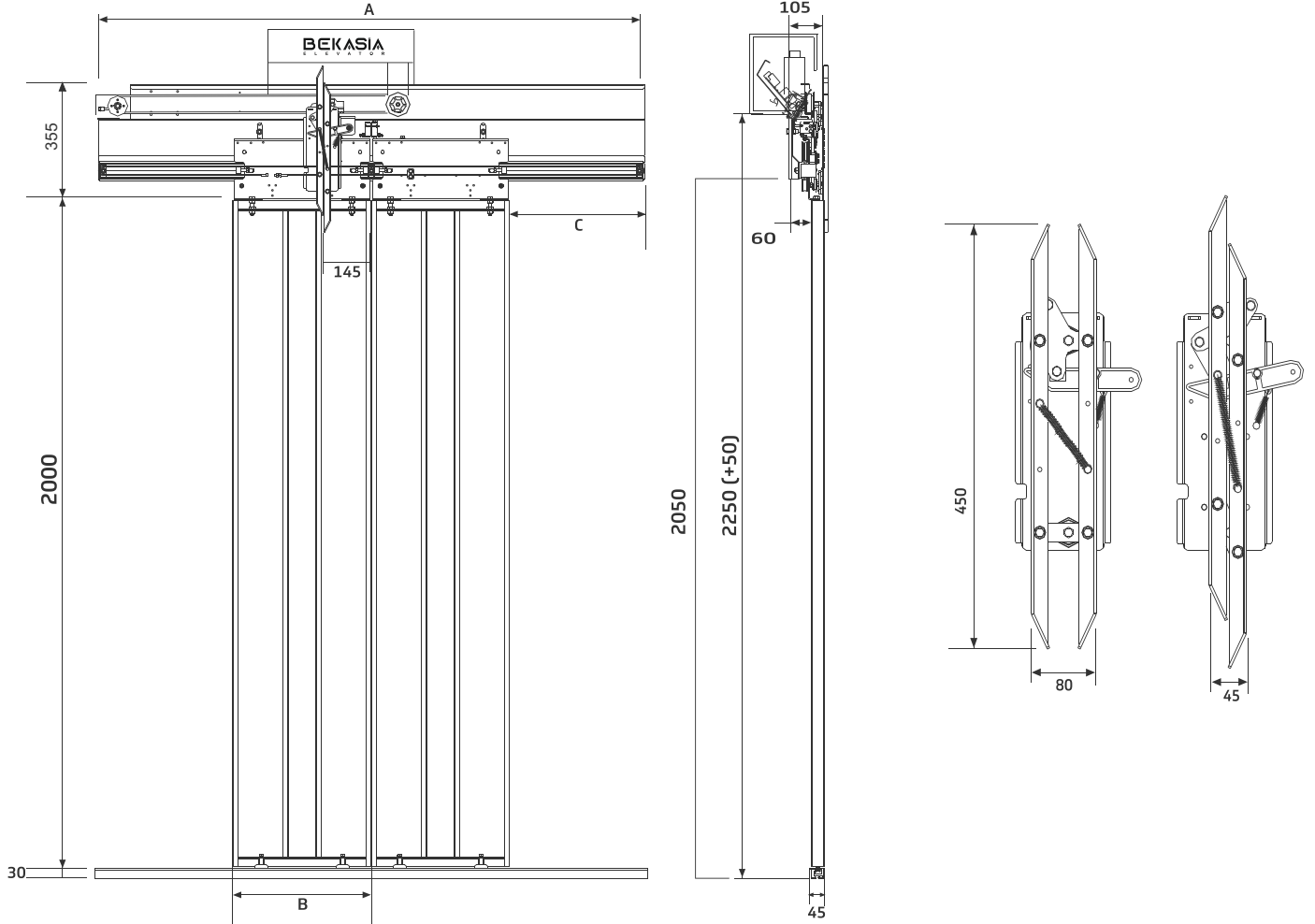

ÖLÇÜLER/DIMENSIONS/DIMENSION/ размеры / أبعاد

Kabin Kapısı / Cabin Door / Porte Cabine / Дверь кабины / باب المصعد

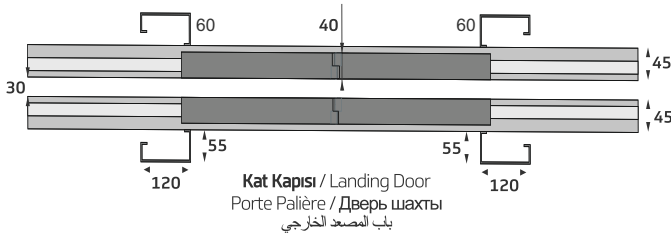

ÖLÇÜLER/DIMENSIONS/DIMENSION/ размеры / أبعاد

PL (mm)	A (mm)	B (mm)	C (mm)
700	1450	370	380
800	1650	420	430
900	1850	470	480
1000	2050	520	530
1100	2250	570	580
1200	2450	620	630
1300	2650	670	680
1400	2850	720	730
1500	3050	770	780
1600	3150	820	830

Kabin Kapısı

Premium Series
VCO4P

Cabin Door / Porte Cabine
Дверь кабины / باب المصعد

Kabin Kapısı



Merkezi 4 Panel Kabin Kapısı

Central Opening 2 Panel Cabin Door

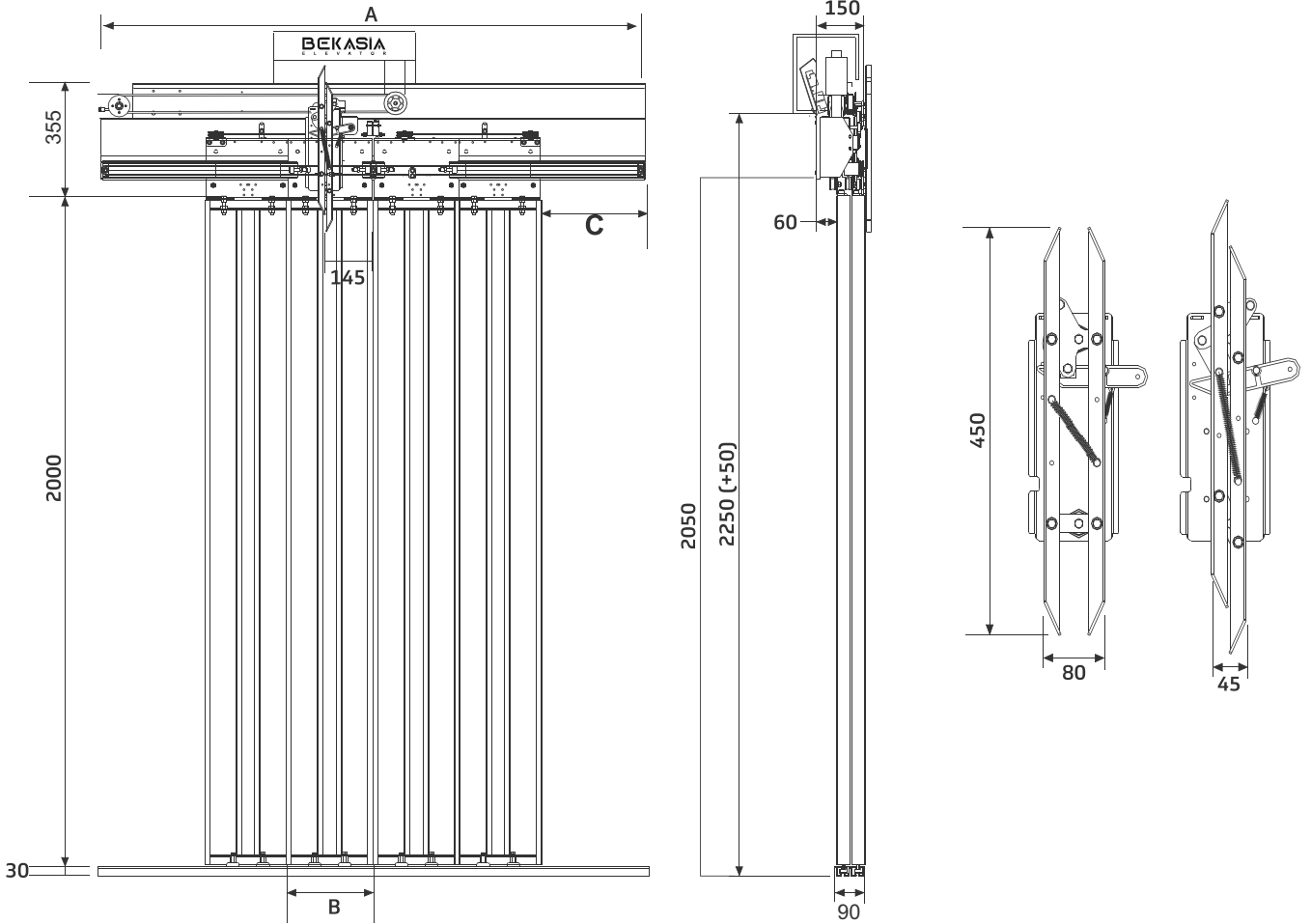

ÖLÇÜLER/DIMENSIONS/DIMENSION/ размеры / أبعاد

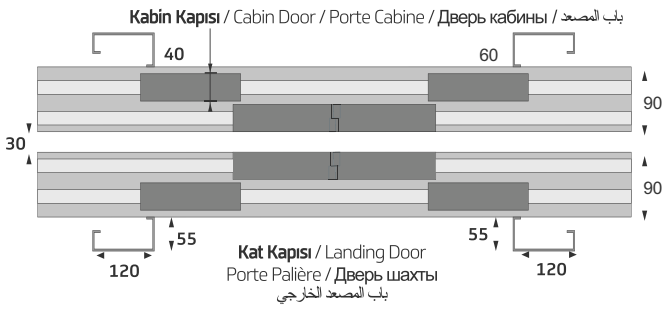

ÖLÇÜLER/DIMENSIONS/DIMENSION/ размеры / أبعاد

PL (mm)	A (mm)	B (mm)	C (mm)
1000	1550	270	280
1100	1700	295	305
1200	1850	320	330
1300	2000	345	355
1400	2150	370	380
1500	2300	395	405
1600	2450	420	430

Kat Kapısı

Premium Series
VTK2P

Kat Kapısı
Landing Door / Porte Pallière
بَاب المصعد الخارجي /
Дверь шахты



Teleskopik 2 Panel Kat Kapısı

Telescopic Opening 2 Panel Landing Door

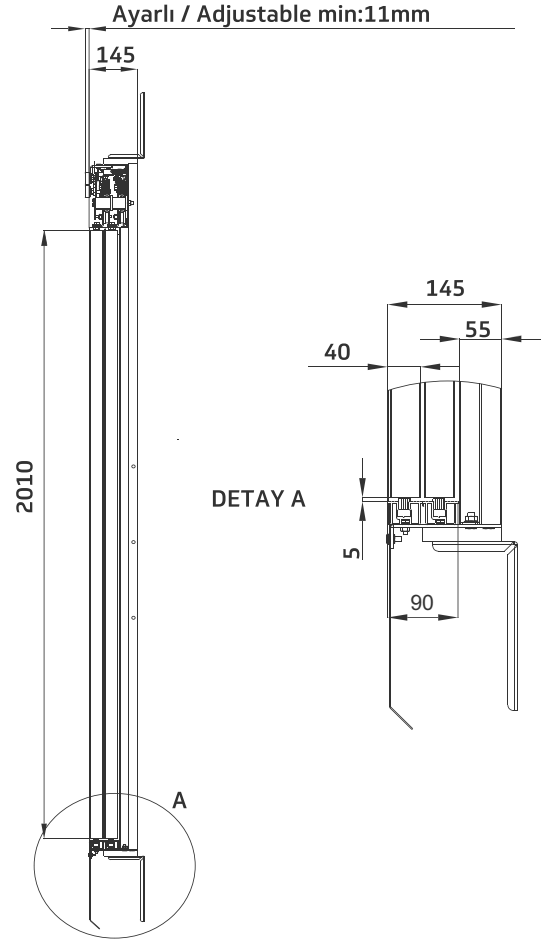
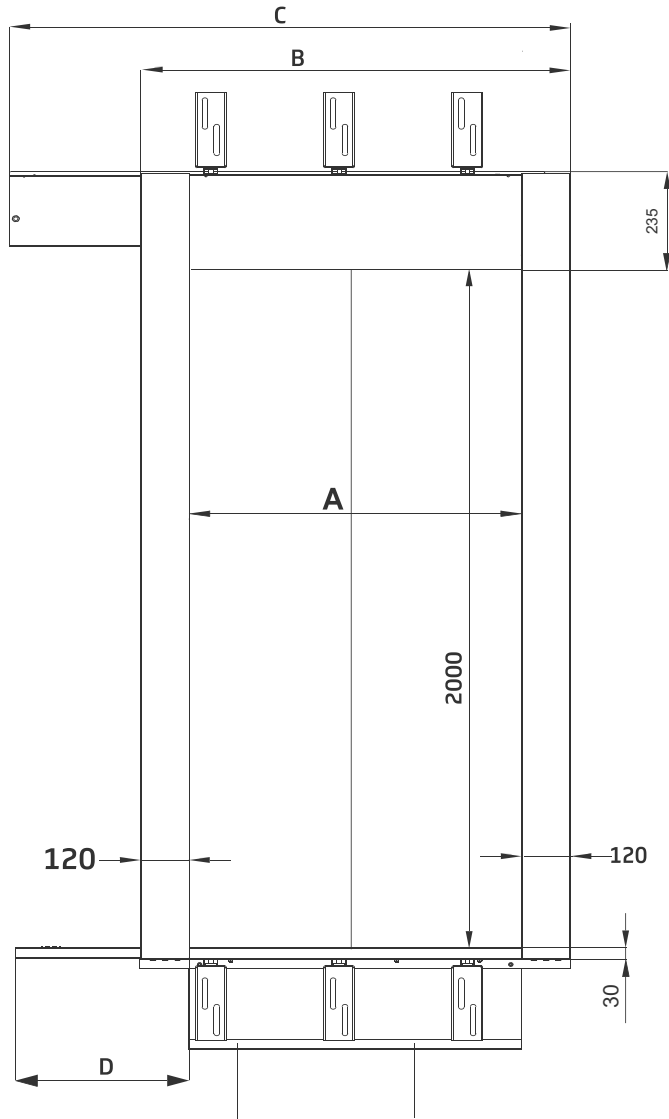

ÖLÇÜLER/DIMENSIONS/DIMENSION/ размеры / أبعاد

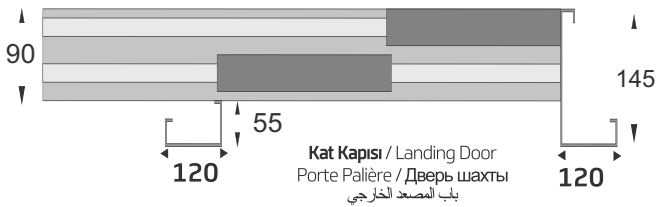

ÖLÇÜLER/DIMENSIONS/DIMENSION/ размеры / أبعاد

A (mm)	B (mm)	C (mm)	D (mm)
700	940	1200	380
800	1040	1350	430
900	1140	1500	4890
1000	1240	1650	530
1100	1340	1800	580
1200	1440	1950	630
1300	1540	2100	680
1400	1640	2250	730
1500	1740	2400	780
1600	1840	2550	830

Kat Kapısı

Premium Series
VTK3P

Landing Door / Porte Pallière
باب المصعد الخارجي /
Дверь шахты

Kat Kapısı



Teleskopik 3 Panel Kat Kapısı

Telescopic Opening 3 Panel Landing Door

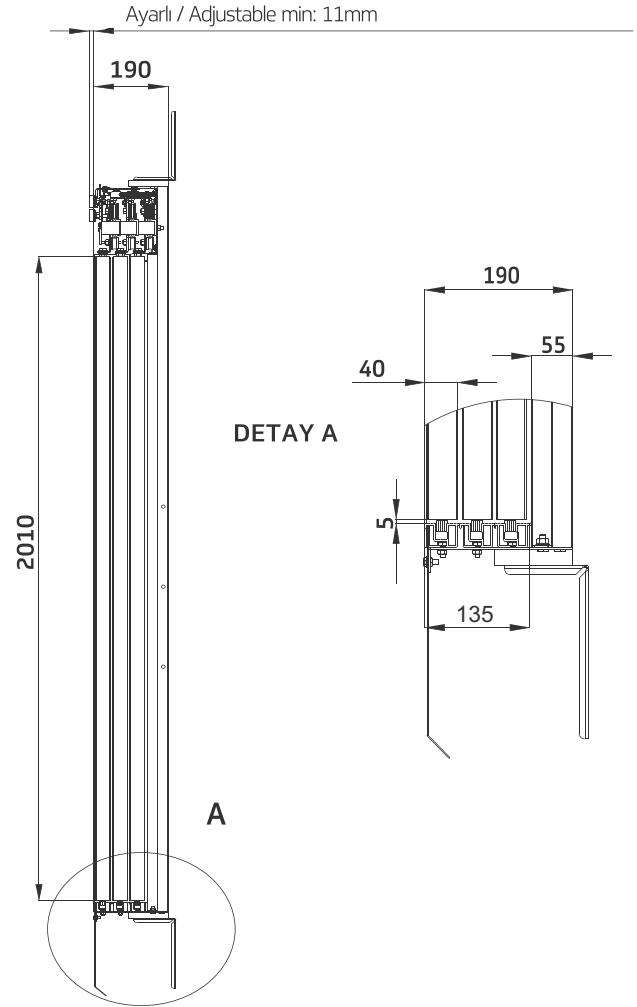
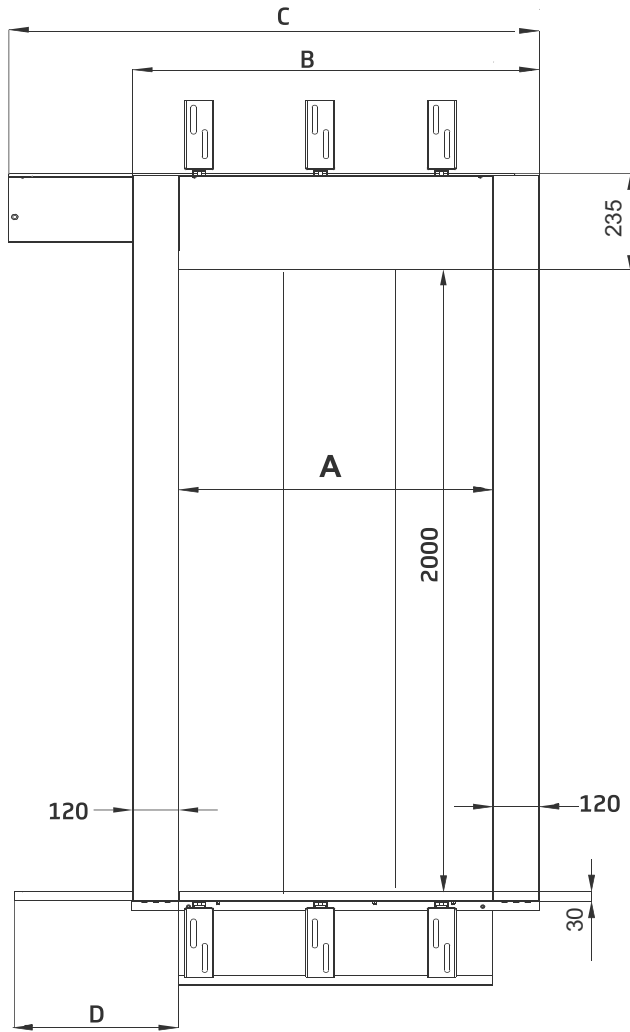

ÖLÇÜLER/DIMENSIONS/DIMENSION/ размеры / أبعاد

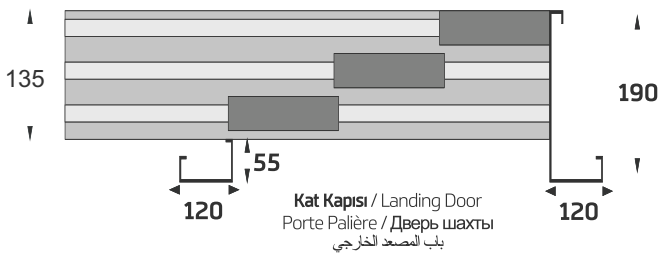

ÖLÇÜLER/DIMENSIONS/DIMENSION/ размеры / أبعاد

A (mm)	B (mm)	C (mm)	D (mm)
800	1040	1217	297
900	1140	1350	330
1000	1240	1483	363
1100	1340	1617	397
1200	1440	1750	430
1300	1540	1883	463
1400	1640	2017	497
1500	1740	2150	530
1600	1840	2283	563

Kat Kapısı

Premium Series
VCK2P

Kat Kapısı
Landing Door / Porte Pallière
باب المصعد الخارجي /
Дверь шахты



Merkezi 2 Panel Kat Kapısı

Central Opening 2 Panel Landing Door

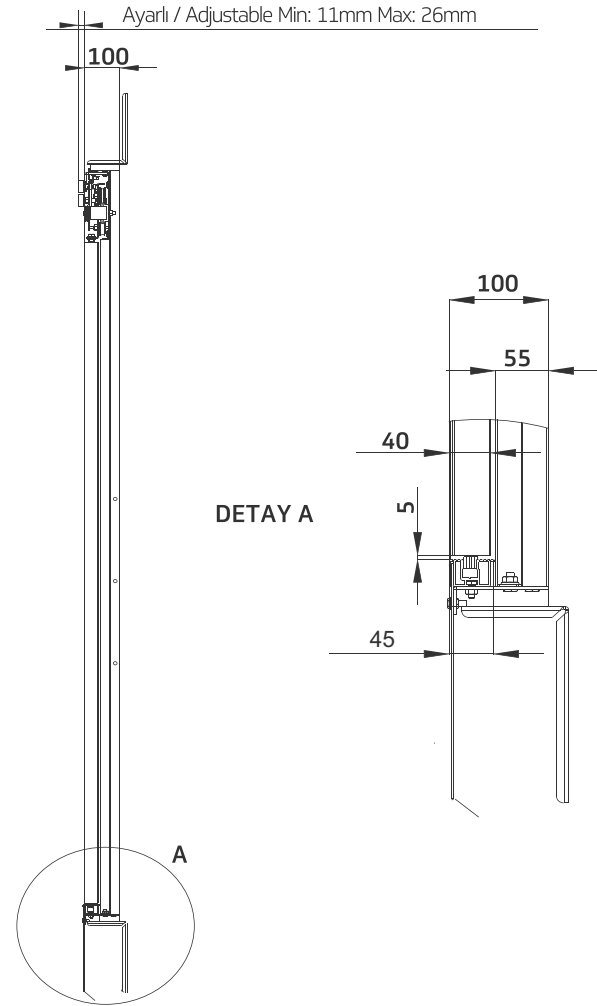
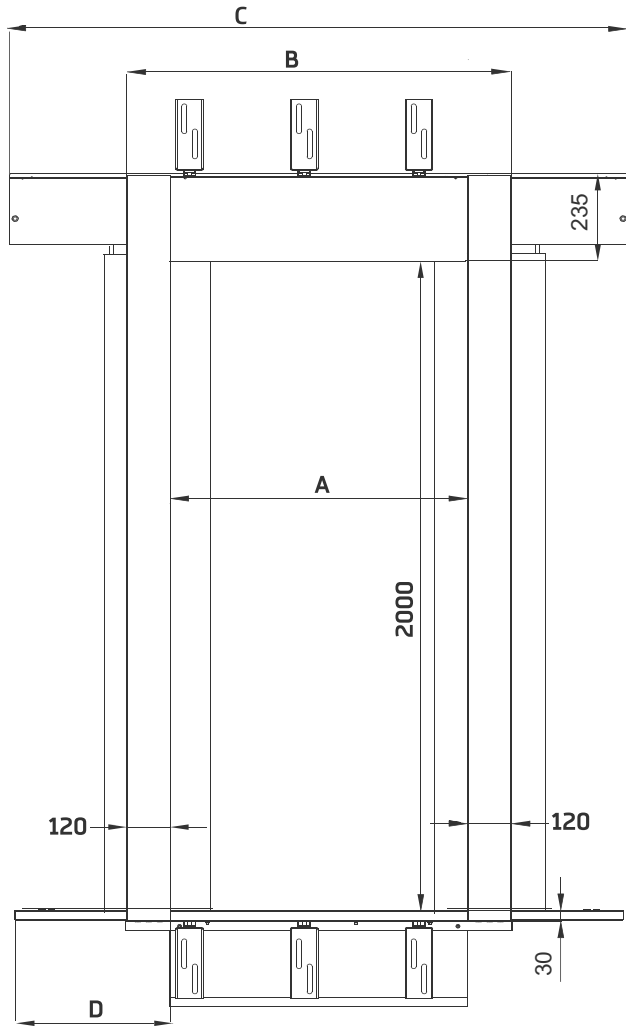

ÖLÇÜLER/DIMENSIONS/DIMENSION/ размеры / أبعاد



ÖLÇÜLER/DIMENSIONS/DIMENSION/ размеры / أبعاد

A (mm)	B (mm)	C (mm)	D (mm)
700	940	1450	380
800	1040	1650	430
900	1140	1850	480
1000	1240	2050	530
1100	1340	2250	580
1200	1440	2450	630
1300	1540	2650	680
1400	1640	2850	730
1500	1740	3050	780
1600	1840	3250	820

Kat Kapısı

Premium Series
VCK4P

Landing Door / Porte Pallière
باب المصعد الخارجي /
Дверь шахты /

Kat Kapısı



Merkezi 4 Panel Kat Kapısı

Central Opening 4 Panel Landing Door

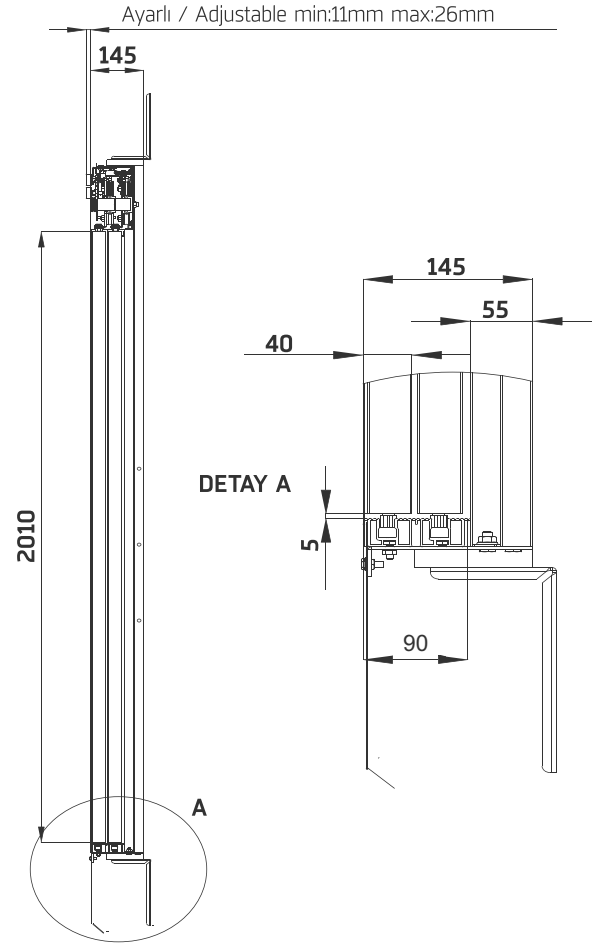
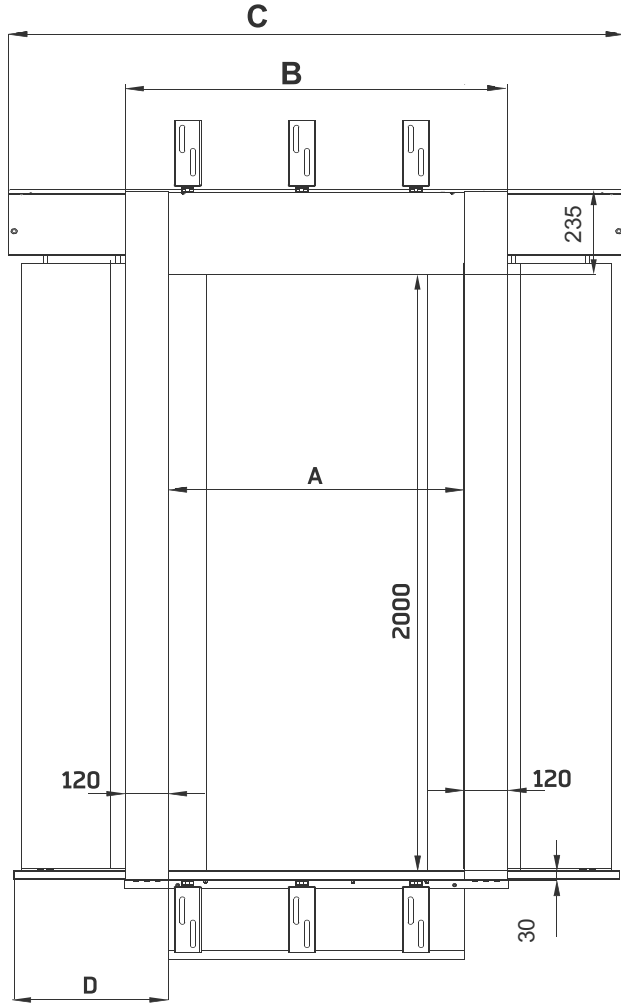

ÖLÇÜLER/DIMENSIONS/DIMENSION/ размеры / أبعاد



ÖLÇÜLER/DIMENSIONS/DIMENSION/ размеры / أبعاد

A (mm)	B (mm)	C (mm)	D (mm)
1000	1240	1550	280
1100	340	1700	305
1200	1440	1850	330
1300	1540	2000	355
1400	1640	2150	380
1500	1740	2300	405
1600	1840	2450	430

Kabin Kapısı

İç Güvenlik Kapıları / Semi-Automatic Door

Premium Series
VTE2P

Cabin Door / Porte Cabine
Дверь кабины / باب المصعد

Kabin Kapısı



Yarı Otomatik Teleskopik 2 Panel Kabin Kapısı

Semi-Automatic Telescopic 2 Panel Cabin Door

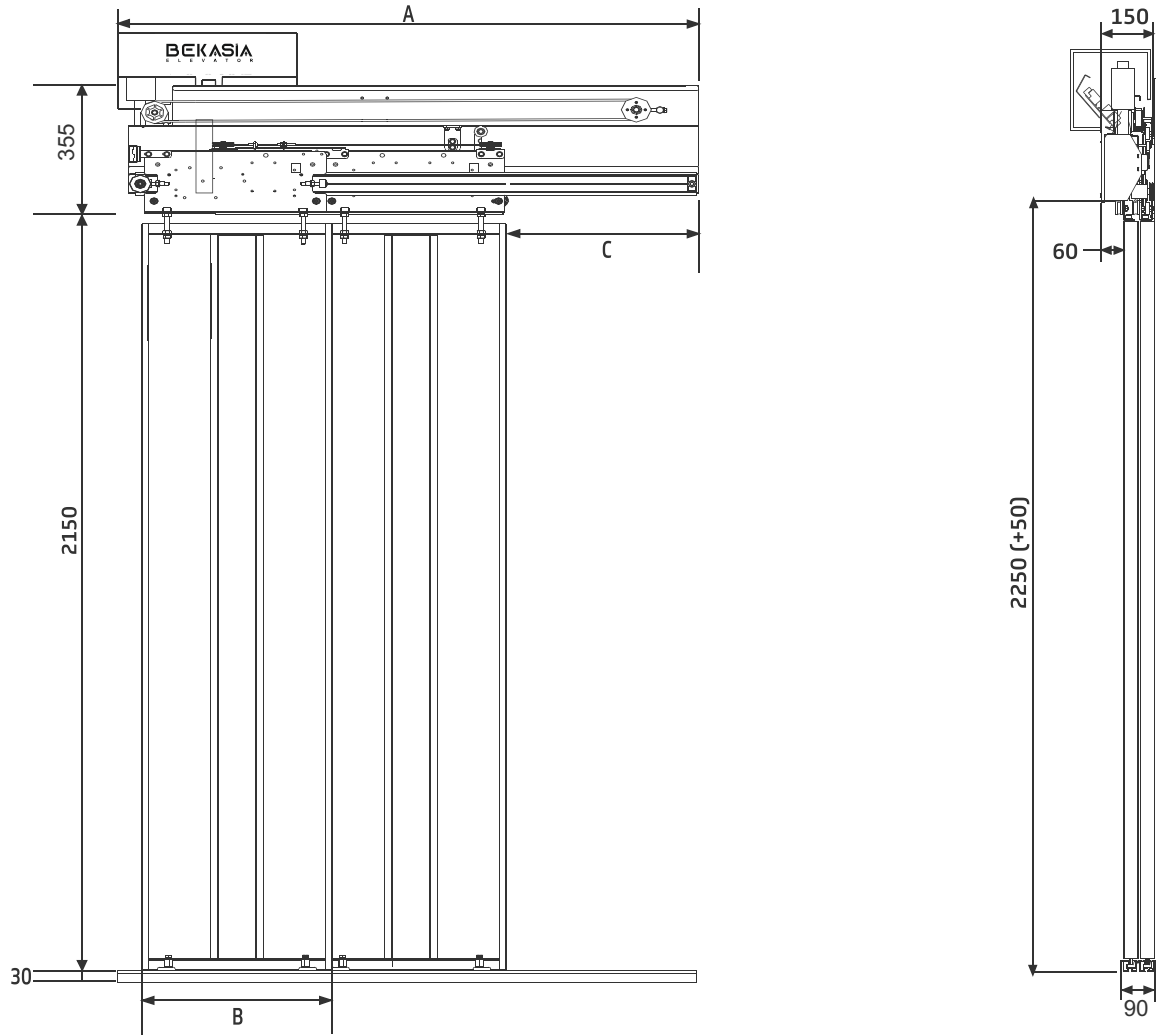

ÖLÇÜLER/DIMENSIONS/DIMENSION/ размеры / أبعاد

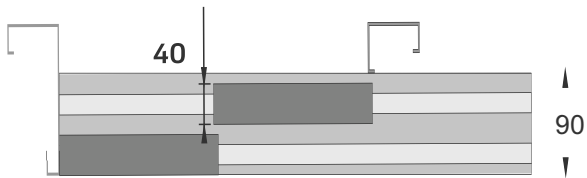

Kabin Kapısı / Cabin Door / Porte Cabine / Дверь кабины / باب المصعد

ÖLÇÜLER/DIMENSIONS/DIMENSION/ размеры / أبعاد

PL (mm)	A (mm)	B (mm)	C (mm)
700	1100	370	380
800	1250	420	430
900	1400	470	480
1000	1550	520	530
1100	1700	570	580
1200	1850	620	630
1300	2000	670	680
1400	2150	720	730
1500	2300	770	780
1600	2450	780	830

Kabin Kapısı

İç Güvenlik Kapıları / Semi-Automatic Door

Premium Series
VTE3P

Cabin Door / Porte Cabine
Дверь кабины / باب المصعد

Kabin Kapısı



Yarı Otomatik Teleskopik 3 Panel Kabin Kapısı

Semi-Automatic Telescopic 3 Panel Cabin Door

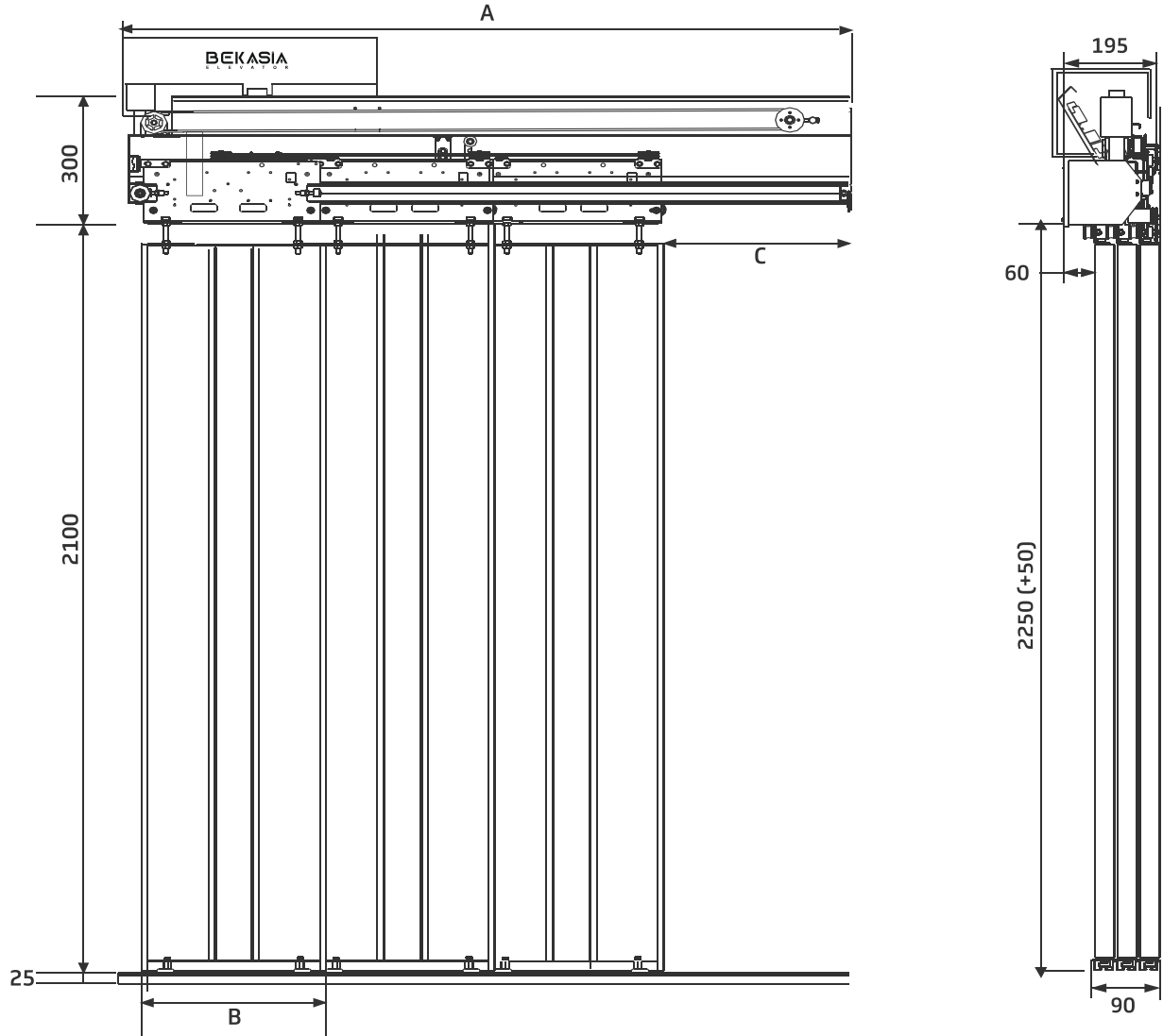

ÖLÇÜLER/DIMENSIONS/DIMENSION/ размеры / أبعاد

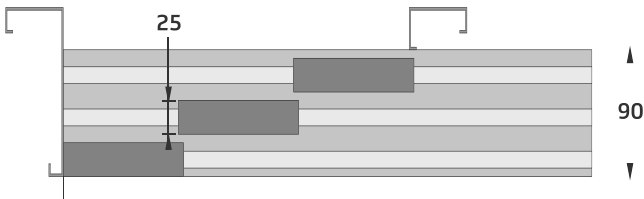

Kabin Kapısı / Cabin Door / Porte Cabine / Дверь кабины / باب المصعد

ÖLÇÜLER/DIMENSIONS/DIMENSION/ размеры / أبعاد

PL (mm)	A (mm)	B (mm)	C (mm)
700	963	246	256
800	1096	280	290
900	1230	313	323
1000	1363	346	356
1100	1496	380	390
1200	1630	413	423
1300	1763	446	456
1400	1896	480	490
1500	2030	514	524
1600	2163	547	558

Kabin Kapısı

İç Güvenlik Kapıları / Semi-Automatic Door

Premium Series
VCE2P

Cabin Door / Porte Cabine
Дверь кабины / باب المصعد

Kabin Kapısı



Yarı Otomatik Merkezi 2 Panel Kabin Kapısı

Semi-Automatic Central Opening 2 Panel Cabin Door

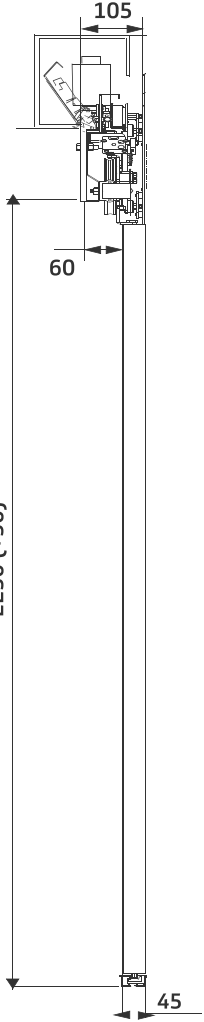
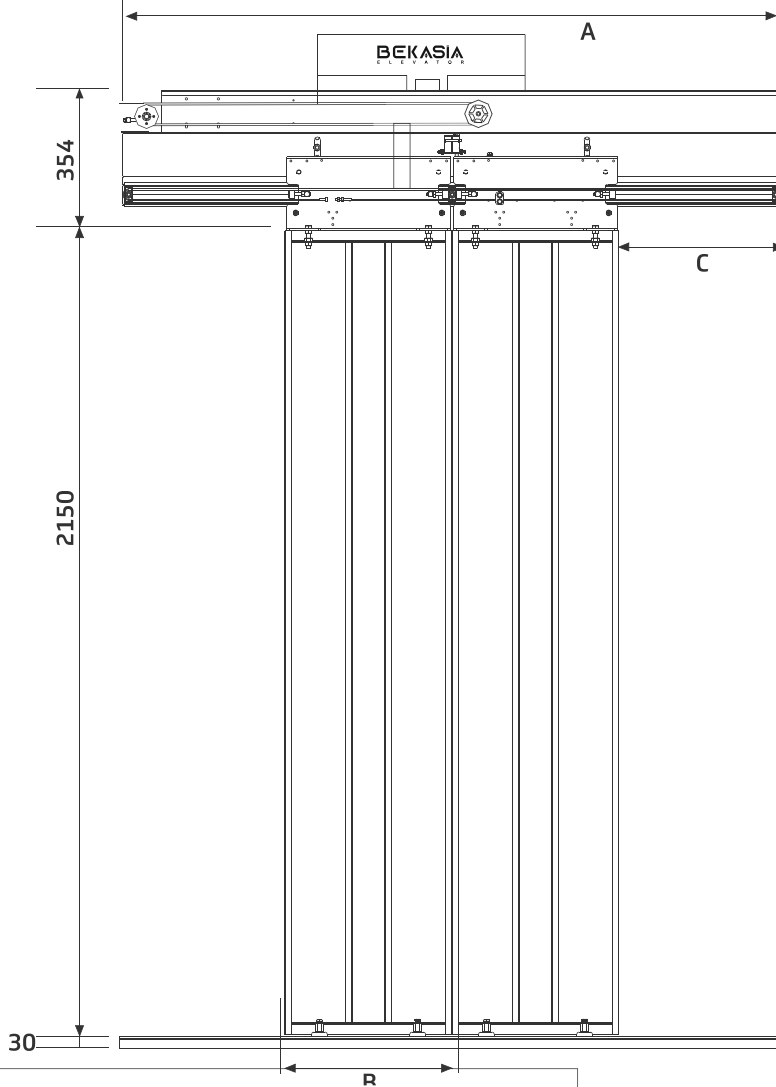

ÖLÇÜLER/DIMENSIONS/DIMENSION/размеры / أبعاد

ÖLÇÜLER/DIMENSIONS/DIMENSION/размеры / أبعاد

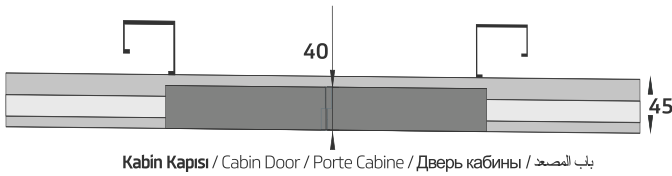

PL (mm)	A (mm)	B (mm)	C (mm)
700	1450	370	380
800	1650	420	430
900	1850	470	480
1000	2050	520	530
1100	2250	570	580
1200	2450	620	630
1300	2650	670	680
1400	2850	720	730
1500	3000	770	780
1600	3150	820	830

Katlanır Kabin Kapısı

İç Güvenlik Kapıları / Semi-Automatic Door

Premium Series

VKR

Cabin Door / Porte Cabine
Дверь кабины / باب المصعد

Kabin Kapısı



Katlanır Kabin Kapısı

Folding Cabin Door

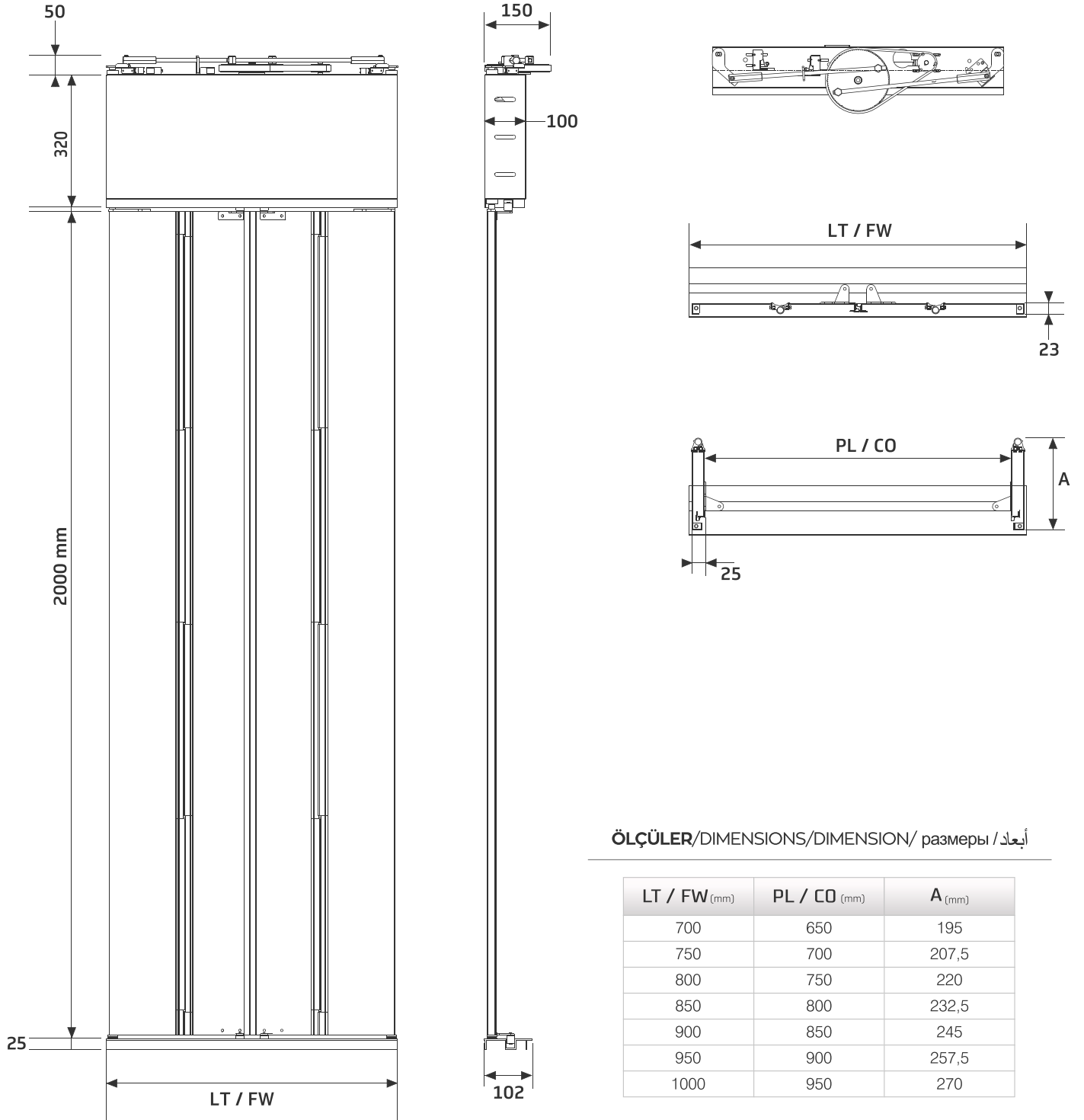

ÖLÇÜLER/DIMENSIONS/DIMENSION/размеры / أبعاد

LT / FW _(mm)	PL / CO _(mm)	A _(mm)
700	650	195
750	700	207,5
800	750	220
850	800	232,5
900	850	245
950	900	257,5
1000	950	270



B



Otomatik / Yarı Otomatik Kapılar

Automatic / Semi-Automatic Doors

Automatic Doors

2 Panel Automatic Doors
 2 Panel Portes Automatiques
2 Панельные Автоматические Двери
 الابواب الاوتوماتيكية من مصراعين



3 Panel Automatic Doors
 3 Panel Portes Automatiques
3 Панельные Автоматические Двери
 الابواب الأوتوماتيكية من ثلاثة مصاريح



Landing Doors
 Portes Paliers
Этажные Двери
 ابواب الطوابق

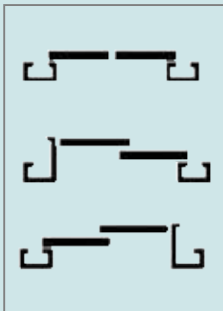

Car Doors
 Portes de Cabine
Дверь кабины
 ابواب الكابينات

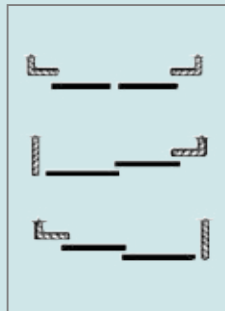

Landing Doors
 Portes Paliers
Этажные Двери
 ابواب الطوابق

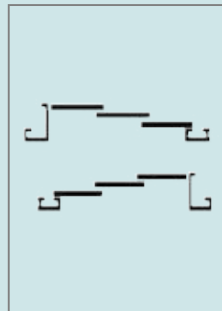

Car Doors
 Portes de Cabine
Дверь кабины
 ابواب الكابينات

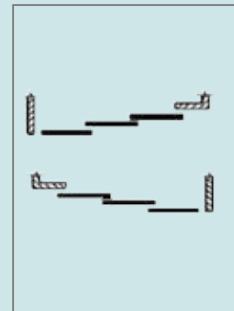

Automatic Doors

4 Panel Automatic Doors
4 Panel Portes Automatiques
4 Панельные Автоматические Двери
الابواب الأوتوماتيكية من 4 مصاريع



Landing Doors
Portes Paliers
Этажные Двери
ابواب الطوابق



Car Doors
Portes de Cabine
Дверь кабины
ابواب الكابينات

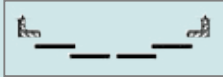

6 Panel Automatic Doors
6 Panel Portes Automatiques
6 Панельные Автоматические Двери
الابواب الأوتوماتيكية من 6 مصاريع



Landing Doors
Portes Paliers
Этажные Двери
ابواب الطوابق

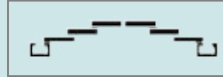

Car Doors
Portes de Cabine
Дверь кабины
ابواب الكابينات



D Type Folding Car Doors
Portes Pliantes- Type D
СКЛАДЫВАЮЩИЕСЯ ДВЕРИ КАБИНЫ ТИПА D
ابواب الكابينات التي تطوب بشكل حرف د

Semi-Automatic Doors

[VA - 101]

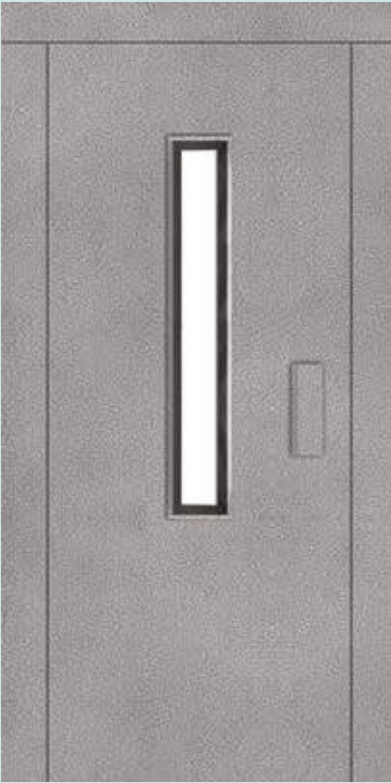

[VA - 102]



[VA - 103]



[VA - 104]



[VA - 105]



[VA - 106]



Semi-Automatic Doors

[VA - 107]



[VA - 108]

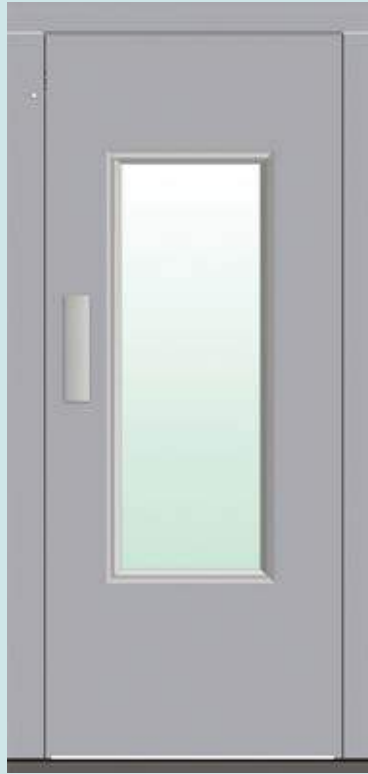

[VA - 109]



[VA - 110]



[VA - 111]



İM O D E R N
İ Y E N İ L İ K Ç İ

KABİNLER

Cabins

BEKASİA
E L E V A T O R

Asansör Kabini

Elevator Cabin

BEK-100



مشخصات

مشخصات
دیوار بغل - لمینات جلا دار 18mm
دیوار پشت سر - نیم آینه
صقف بالا - چراغ های led لاطری
کف زمین - گرنیت
تجهيزات جانبی - آینه استیل خش دار
دستگیر mm-

Specifications

Side Walls - 18 mm High Gloss Laminate
Back Wall - Half Mirror
Ceiling - Laser Ceiling
Floor - Antibacterial PVC Floor
Accessories - Mirror Stainless
Handrail - 32mm Chrome Handrails

Özellikler

Yan Duvar - 18 mm Çok Parlak Laminant
Arka Duvar - Yarım Ayna
Tavan - Lazer Kesme, Led Aydınlatma
Taban - Granit
Aksesuarlar - Ayna Paslanmaz
Tutamak - 32 mm Krom Kulp

Спецификации

Боковые стенки - 18 мм Высокогляцевый ламинат
Задняя стенка - Зеркало в полроста
Потолок - Лазерный потолок
Пол - Антибактериальное покрытие из ПВХ
Аксессуары - Зеркало из нержавеющей стали
Поручень - 32 мм Хромовые поручни

الخصائص

الجدران الجانبية 18 مم هاي جلاس
الجدار الخلفي مرآة نصفية
السقف ليزر
الأرضية مضاد للبكتيريا
الاكسسوارات مرآة غير قابلة للصدأ
الحافة العليا 32مم كروم

Cabins / Cabine / Кабины / الكابينات

BEKASIA
E L E V A T O R

Asansör Kabini

Elevator Cabin

BEK-200



مشخصات

مشخصات
دیوار بغل - لمینات جلا دار 18mm
دیوار پشت سر - نیم ایینه
صاف بالا - چراغ های led لاطری
کف زمین - گرنیت
تجهیزات جانبی - ایینه استیل خش دار
دستگیر mm-

Specifications

Side Walls - 18mm Laminate
Back Wall - Laminate+ Black Mirror Stainless
Ceiling - Black Laser ceiling
Floor - Granite
Accessories - Mirror Stainless
Handrail - 32mm Chrome Handrails

Özellikler

Yan Duvar - 18 mm Çok Parlak Laminant
Arka Duvar - Yarım Ayna
Tavan - Lazer Kesme, Led Aydınlatma
Taban - Granit
Aksesuarlar - Ayna Paslanmaz
Tutamak - 32 mm Krom Kulp

Спецификации

Боковые стены - 18 мм ламинант
Задняя стенка - Ламинант + Черное Зеркало из нержавеющей стали
Потолок - Черный Лазерный потолок
Пол - Гранит
Аксессуары - Зеркало из нержавеющей стали
Поручень - 32 мм Хромовые поручни

الخصائص

الجدران الجانبية 18 لاميننت
الجدار الخلفي لاميننت ومرآة سوداء غير قابلة للصدأ
السقف ليزر مرآة سوداء
الأرضية غرانيت
الاكسسوارات مرآة غير قابلة للصدأ
الحافة العليا 32مم كروم

BEKASIA
E L E V A T O R

Cabins / Cabine / Кабины / الكابينات

Asansör Kabini

Elevator Cabin

BEK-300



مشخصات

مشخصات
دیوار بغل - لمینات جلادار 18mm
دیوار پشت سر - نیم آینه
صقف بالا - چراغ های led لاطری
کف زمین - گرنیت
تجهيزات جانبی - آینه استیل خش دار
دستگیر mm-

Specifications

Side Walls - 18mm Laminate
Back Wall - 18mm Laminate
Ceiling - Laser Ceiling, LED Lighting
Floor - Antibacterial PVC
Accessories - Mirror Stainless
Handrail - 32mm Chrome Handrails

Özellikler

Yan Duvar - 18 mm Çok Parlak Laminant
Arka Duvar - Yarım Ayna
Tavan - Lazer Kesme, Led Aydınlatma
Taban - Granit
Aksesuarlar - Ayna Paslanmaz
Tutamak - 32 mm Krom Kulp

Спецификации

Боковые стены - 18 мм ламинант
Задняя стенка - 18 мм ламинант
Потолок - Лазерный потолок + Светодиодное
освещение
Пол - Антибактериальное покрытие из ПВХ
Аксессуары - Зеркало из нержавеющей
Поручень - 32 мм Хромовые поручни

الخصائص

الجدان الجانبية 18 مم لاميننت
الجدان الخلفي 18 مم لاميننت
السقف ليزر مع اضائة ليد
الأرضية مضاد للبكتيريا
الاكسسوارات مرآة غير قابلة للصدأ
الحافة العليا 32مم كروم

Cabins / Cabine / Кабины / الكابينات

BEKASIA
E L E V A T O R

Asansör Kabini

Elevator Cabin

BEK-400



BEKASIA
E L E V A T O R

Cabins / Cabine / Кабины / الكابينات

مشخصات

مشخصات
دیوار بغل - لمینات جلادار 18mm
دیوار پشت سر - نیم آینه
صاف بالا - چراغ های led لاطری
کف زمین - گرنیت
تجهیزات جانبی - آینه استیل خش دار
دستگیر mm-

Specifications

Side Walls - 18mm Laminate
Back Wall - 18 mm Laminate
Ceiling - Laser Ceiling
Floor - Granite
Accessories - Mirror Stainless
Handrail - 32mm Chrome Handrails

Özellikler

Yan Duvar - 18 mm Çok Parlak Laminant
Arka Duvar - Siyah Ayna Paslanmaz
Tavan - Lazer Kesme, Led Aydınlatma
Taban - Granit
Aksesuarlar - Ayna Paslanmaz
Tutamak - 32 mm Krom Kulp

Спецификации

Боковые стены - 18 мм ламинант
Задняя стенка - 18 мм ламинант
Потолок - Лазерный потолок
Пол - Гранит
Аксессуары - Зеркало из нержавеющей стали
Поручень - 32 мм Хромовые поручни

الخصائص

الجدران الجانبية 18 مم لاميننت
الجدار الخلفي 18 مم لاميننت
السقف ليزر
الأرضية غرانيت
الاكسسوارات مرآة غير قابلة للصدأ
الحافة العليا 32مم كروم

Asansör Kabini

Elevator Cabin

BEK-500



مشخصات

مشخصات
دیوار بغل - موبیل (تخته بی)
دیوار پشت سر - مکمل آینه
صف بالایی - برق های LED (لاظری)
کف زمین - گرنیت
تجهیزات جانبی - آینه استیل خش دار
دست گیر - ۳۲ مم

Specifications

Side Walls – 18mm Membrane Coating
Back Wall – Full Mirror
Ceiling – LED + Spot Lighting
Floor – Granite
Accessories – Mirror Stainless
Handrail – 32mm Chrome Handrails

Özellikler

Yan Duvar - 18 mm Membran Kaplama
Arka Duvar - Beyaz Ayna Paslanmaz
Tavan - Lazer Kesme, Led Aydınlatma
Taban - Granit
Aksesuarlar - Beyaz Ayna Paslanmaz
Tutamak - 32 mm Krom Kulp

Спецификации

Боковые стены – 18 мм мембранное покрытие
Задняя стенка – Зеркало в рост
Потолок - Точечный светильник + светодиод
Пол - Гранит
Аксессуары - Зеркало из нержавеющей стали
Поручень - 32 мм Хромовые поручни

الخصائص

الجدان الجانبية 18 مم مبران
الجدان الخلفي مرآة كاملة
السقف أضائة ليد
الأرضية غرانيت
الأكسسوارات مرآة غير قابلة للصدأ
الحافة العليا 32مم كروم

Cabins / Cabine / Кабины / الكابينات

BEKASIA
E L E V A T O R

Asansör Kabini

Elevator Cabin

BEK-600



مشخصات

مشخصات
دیوار بغل - موبل (تخته پی) ۱۸ MM
دیوار پشت سر - مکمل آینه
صاف بالا - (لاطری) چراغ های LED
کف زمین - گرنیت
تجهیزات جانبی - آینه استیل خش دار
دست گیر - 32 MM

Specifications

Side Walls – 18mm Divided Membrane Coating
Back Wall – Full Mirror
Ceiling – Laser Ceiling
Floor – Granite
Accessories – Mirror Stainless
Handrail – 32mm Chrome Handrails

Özellikler

Yan Duvar - 18 mm Bölünmüş Membran
Arka Duvar - Beyaz Ayna Paslanmaz
Tavan - Lazer Tavan, Led Aydınlatma
Taban - Granit
Aksesuarlar - Beyaz Ayna Paslanmaz
Tutamak - 32 mm Krom Kulp

Спецификации

Боковые стены - 18 мм Частично мембранные
наложения
Задняя стенка - Зеркало в рост
Потолок - Лазерный потолок
Пол - Гранит
Аксессуары - Зеркало из нержавеющей
Поручень - 32 мм Хромовые поручни

الخصائص

الجدران الجانبية 18 مم ميرام قطع
الجدار الخلفي مرآة كاملة
السقف ليزر
الأرضية غرانيت
الاكسسوارات مرآة غير قابلة للصدأ
الحافة العليا 32مم كروم

BEKASIA
E L E V A T O R

Cabins / Cabine / Кабины / الكابينات

Asansör Kabini

Elevator Cabin

BEK-700



مشخصات

مشخصات
دیوار بغل - موبل (تخته پی) ۱۸ مم
دیوار پشت سر - مکمل آینه
صف بالا - شیشه 3D + چراغ های LED
کف زمین - گرنیت
تجهیزات جانبی - آینه استیل خش دار
دست گیر - ۳۲ مم

Specifications

Side Walls – 18mm Divided Membrane Coating
Back Wall – Full Mirror
Ceiling – 3D Glass and LED Lighting
Floor – Granite
Accessories – Mirror Stainless
Handrail – 32mm Chrome Handrails

Özellikler

Yan Duvar - 18 mm Bölünmüş Membran
Arka Duvar - Beyaz Ayna Paslanmaz
Tavan - 3D Cam ve Led Aydınlatma
Taban - Granit
Aksesuarlar - Beyaz Ayna Paslanmaz
Tutamak - 32 mm Krom Kulp

Спецификации

Боковые стены - 18 мм мембранные наложения
Задняя стенка - Зеркало в рост
Потолок - 3хмерное стекло + Светодиодное
освещение
Пол - Гранит
Аксессуары - Зеркало из нержавеющей
Поручень - 32 мм Хромовые поручни

الخصائص

الجدان الجانبية
الجدان الخلفي
السقف
الأرضية
الأكسسوارات
الحافة العليا
قطع مبرام مم 18
مرآة كاملة
كاميرا ثلاث ابعاد مع اضاءة ليد
غرانيت
مرآة غير قابلة للصدأ
32مم كروم

Cabins / Cabine / Кабины / الكابينات

BEKASIA
E L E V A T O R

Asansör Kabini

Elevator Cabin

BEK-800



BEKASIA
E L E V A T O R

Cabins / Cabine / Кабины / الكابينات

مشخصات

مشخصات
دیوار بغل - موبل (تخته پی)
دیوار پشت سر - نیمه آینه
صاف بالا- (لاطری) چراغ ها LED
صاف زمین - گرنیت
تجهیزات جانبی - آینه استیل خش دار
دست گیر - ۳۲ مم

Specifications

Side Walls – 18mm Membrane Coating
Back Wall – Half Mirror
Ceiling – Laser Ceiling
Floor – Granite
Accessories – Mirror Stainless
Handrail – 32mm Chrome Handrails

Özellikler

Yan Duvar - 18 mm Bölünmüş Membran
Arka Duvar - Yarım Cam
Tavan - Led Tavan, Led Aydınlatma
Taban - Granit
Aksesuarlar - Beyaz Ayna Paslanmaz
Tutamak - 32 mm Krom Kulp

Спецификации

Боковые стены - 18 мм Частично мембранные наложения
Задняя стенка - Зеркало в полроста
Потолок - Лазерный потолок
Пол - Гранит
Аксессуары - Зеркало из нержавеющей стали
Поручень - 32 мм Хромовые поручни

الخصائص

الجدران الجانبية 18 مم مبران
الجدار الخلفي مرآة نصفية
السقف ليزر
الأرضية غرانيت
الاكسسوارات مرآة غير قابلة للصدأ
الحافة العليا 32مم كروم

Asansör Kabini

Elevator Cabin

BEK-900



مشخصات

مشخصات
دیوار بغل - فولاد زد زنگ +لمینات
دیوار پشت سر - نیمه ایینه
صقف بالا- (لاطری) برق های LED
کف زمین - PVC
تجهيزات جانبی - ایینه استیل خش دار
دست گیر - ۳۲ MM

Specifications

Side Walls – Stainless Steel with 18mm Laminate Coating
Back Wall – Half Mirror
Ceiling – Laser Ceiling
Floor – Antibacterial PVC Floor
Accessories – Mirror Stainless
Handrail – 32mm Chrome Handrails

Özellikler

Yan Duvar - 18 mm Laminant Kaplama
Arka Duvar - Yarım Ayna
Tavan - Lazer Tavan, Led Aydınlatma
Taban - PVC
Aksesuarlar -Beyaz Ayna Paslanmaz
Tutamak - 32 mm Krom Kulp

Спецификации

Боковые стены - 18мм Нержавеяка с покрытием из ламината
Задняя стенка - Зеркало в полроста
Потолок - Лазерный потолок
Пол - Антибактериальное покрытие из ПВХ
Аксессуары - Зеркало из нержавеющей
Поручень - 32 мм Хромовые поручни

الخصائص

الجدان الجانبية
ساتينا غير قابل للصدأ 18 مم
لمنانت
الجدار الخلفي
مرآة نصفية
السقف
ليزر
الأرضية
مضاد للبكتيريا
الاكسسوارات
مرآة غير قابلة للصدأ
الحافة العليا
32مم كروم

Cabins / Cabine / Кабины / الكابينات

BEKASIA
E L E V A T O R

BEKASIA
E L E V A T O R

KALİTELİ
& ŞİK TASARIMLAR

Güvenliğiniz Emin Ellerde...

Asansör Kabini

Elevator Cabin

BEK-1000



مشخصات

مشخصات
دیوار بغل - آینه سیاه زد زریه 6mm
دیوار پشت سر - مکمل آینه
صاف بالا - چراغ های (لاطری) LED
کف زمین - سنگ مرمر
تجهيزات جانبی - آینه استیل خش دار
دست گیر - ۳۳ MM

Specifications

Side Walls - 6mm Tempered Black Glass
Back Wall - Full Mirror
Ceiling - Laser Ceiling
Floor - Granite
Accessories - Mirror Stainless
Handrail - 32mm Chrome Handrails

Özellikler

Yan Duvar - 6 mm Temperli Siyah Cam
Arka Duvar - Beyaz Ayna Paslanmaz
Tavan - Lazer Tavan, Led Aydınlatma
Taban - Granit
Aksesuarlar - Beyaz Ayna Paslanmaz
Tutamak - 32 mm Krom Kulp

Спецификации

Боковые стены - 6 мм Закаленное черное стекло
Задняя стенка - Зеркало в рост
Потолок - Лазерный потолок
Пол - Гранит
Аksesuarlar - Зеркало из нержавеющей
Поручень - 32 мм Хромовые поручни

الخصائص

الجدان الجانبية
الجدان الخلفي
السقف
الأرضية
الاكسسوارات
الحافة العليا
زجاج اسود 6 مم
مرآة كاملة
ليزر
غرانيت
مرآة غير قابلة للصدأ
32مم كروم

BEKASIA
E L E V A T O R

Cabins / Cabine / Кабины / الكابينات

Asansör Kabini

Elevator Cabin

BEK-1100

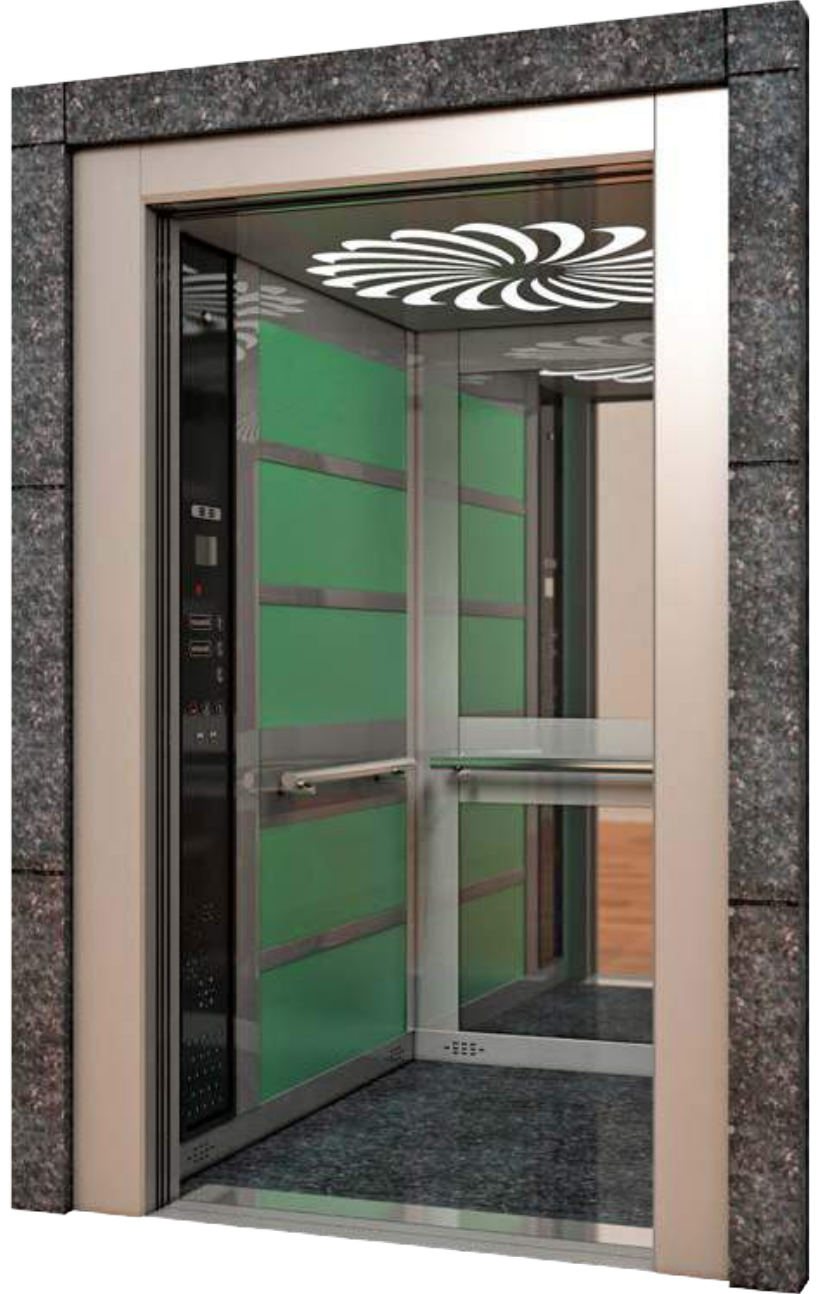

مشخصات

مشخصات
دیوار بغل - استیل خشدار
دیوار پشت سر - آینه سفید استیل خشدار
صف بالا- لاطری . چراغ های LED
صف پایین - گرنیت
تجهیزات جانبی - آینه سفید استیل خش دار
دست گیر - ۳۲ مم

Specifications

Side Walls - 6mm Tempered Turquoise Green Glass
Back Wall - Full Mirror
Ceiling - Laser Ceiling
Floor - Granite
Accessories - Mirror Stainless
Handrail - 32mm Chrome Handrails

Özellikler

Yan Duvar - 6 mm Temperli Turkuaz Yeşil Cam
Arka Duvar - Beyaz Ayna Paslanmaz
Tavan - Lazer Tavan, Led Aydınlatma
Taban - Granit
Aksesuarlar - Beyaz Ayna Paslanmaz
Tutamak - 32 mm Krom Kulp

Спецификации

Боковые стены - 6 мм Закаленное стекло, Бирюзовое, Зеленое
Задняя стенка - Зеркало в рост
Потолок - Лазерный потолок
Пол - Гранит
Аксессуары - Зеркало из нержавеющей стали
Поручень - 32 мм Хромовые поручни

الخصائص

الجدران الجانبية زجاج اسود 6 مم
الجدار الخلفي مرآة كاملة
السقف ليزر
الأرضية مضاد للبكتيريا غرانيت
الاكسسوارات مرآة غير قابلة للصدأ
الحافة العليا 32مم كروم

Cabins / Cabine / Кабины / الكابينات

BEKASIA
E L E V A T O R

Asansör Kabini

Elevator Cabin

BEK-1200



BEKASIA
E L E V A T O R

Cabins / Cabine / Кабины / الكابينات

مشخصات

مشخصات
دیوار بغل - ستیل خشدار
دیوار پشت سر- آینه سفید استیل خشدار
صق بال-برق های LED (لاظری)
کف زمین- PVC
تجهيزات جانبی- آینه استیل خشدار
دستگیر- ۳۲ MM

Specifications

Side Walls - Stainless Steel
Back Wall - Full Mirror
Ceiling - Laser Ceiling
Floor - Antibacterial PVC
Accessories - Mirror Stainless
Handrail - 32mm Chrome Handrails

Özellikler

Yan Duvar - Paslanmaz Çelik
Arka Duvar - Beyaz Ayna Paslanmaz
Tavan - Lazer Tavan, Led Aydınlatma
Taban - Antibakteriyel PVC
Aksesuarlar - Beyaz Ayna Paslanmaz
Tutamak - 32 mm Krom Kulp

Спецификации

Боковые стены - Покрытие из нержавеющей стали
Задняя стенка - Зеркало в рост
Потолок - Лазерный потолок
Пол - Антибактериальное покрытие из ПВХ
Аксессуары - Зеркало из нержавеющей стали
Поручень - 32 мм Хромовые поручни

الخصائص

الجدران الجانبية
الجدار الخلفي
السقف
الأرضية
الاكسسوارات
الحافة العليا
ساتينا غير قابل للصدأ
مرآة كاملة
ليزر
مضاد للبكتيريا
مرآة غير قابلة للصدأ
32مم كروم

Asansör Kabini

Elevator Cabin

BEK-1300



مشخصات

مشخصات
دیوار بغل - ایینه سیاه استیل خشدار
دیوار پشت سر - ایینه سیاه استیل خشدار
صاف بالا- چراغ های (لاطری) LED
کف زمین - گرنیت
تجهيزات جانبی - ایینه استیل خش دار
دست گیر - MM32

Specifications

Side Walls – Black Mirror Stainless
Back Wall – Black Mirror Stainless
Ceiling – Laser Ceiling
Floor – Granite
Accessories – Mirror Stainless
Handrail – 32mm Chrome Handrails

Özellikler

Yan Duvar - Siyah Ayna Paslanmaz
Arka Duvar - Siyah Ayna Paslanmaz
Tavan - Lazer Tavan, Led Aydınlatma
Taban - Granit
Aksesuarlar - Beyaz Ayna Paslanmaz
Tutamak - 32 mm Krom Kulp

Спецификации

Боковые стены - Черное Зеркало из нержавеющей
Задняя стенка - Черное Зеркало из нержавеющей
Потолок - Лазерный потолок
Пол - Гранит
Аксессуары - Зеркало из нержавеющей
Поручень - 32 мм Хромовые поручни

الخصائص

الجدان الجانبية
الجدار الخلفي
السقف
الأرضية
الاكسسوارات
الحافة العليا
مرآة سوداء غير قابلة للصدأ
مرآة سوداء غير قابلة للصدأ
ليزر
غرانيت
مرآة غير قابلة للصدأ
32مم كروم

Cabins / Cabine / Кабины / الكابينات

BEKASIA
E L E V A T O R

Asansör Kabini

Elevator Cabin

BEK-1400



BEKASIA
E L E V A T O R

Cabins / Cabine / Кабины / الكابينات

مشخصات

مشخصات
دیوار بغل - موبل (تخته بی)
دیوار پشت سر - سنگ طبیعی
صاف بالا - شیشه 3D و چراغ های LED
کف زمین - پارچه های گرنیت
تجهیزات جانبی - آینه استیل خش دار
دست گیر - MM 32

Specifications

Side Walls - 18mm Membrane Coating
Back Wall - Naturel Stone
Ceiling - 3D Glass and Led Lighting
Floor - Divided Granite+ Glass
Accessories - Mirror Stainless
Handrail - 32mm Chrome Handrails

Özellikler

Yan Duvar - 18 mm Membran Kaplama
Arka Duvar - Yarım Ayna
Tavan - 3D Cam ve Led Aydınlatma
Taban - Granit - Cam
Aksesuarlar - Beyaz Ayna Paslanmaz
Tutamak - 32 mm Krom Kulp

Спецификации

Боковые стены - 18 мм мембранное покрытие
Задняя стенка - Натуральный камень
Потолок - 3D-стекло + Светодиодное освещение
Пол - Компонентный Гранит + Стекло
Аксессуары - Зеркало из нержавеющей стали
Поручень - 32 мм Хромовые поручни

الخصائص

الجدران الجانبية 18 مم مبران
الجدار الخلفي حجر طبيعي
السقف ليزر مع كاميرا ثلاثية الأبعاد
الأرضية غرانيت قطع مع كاميرا
الاكسسوارات مرآة غير قابلة للصدأ
الحافة العليا 32مم كروم

Asansör Kabini

Elevator Cabin

BEK-1500



مشخصات

مشخصات
دیوار بغل - دیکور طلائی با فلز
دیوار پشت سر - سنگ های طبیعی
صاف بالا - شیشه 3D و چراغ های LED
کف زمین - گرانیت
تجهیزات جانبی - آینه استیل خش دار به رنگ طلائی
32 دست گیر - MM

Specifications

Side Walls – Golden Decorative Stainless Steel
Back Wall – Naturel Stone
Ceiling – 3D Glass and Led Lighting
Floor – Granite
Accessories – Golden Mirror Stainless
Handrail – 32mm Chrome Handrails

Özellikler

Yan Duvar - Altın Dekoratif Paslanmaz Çelik
Arka Duvar - Doğal Taş
Tavan - 3D Cam ve Led Aydınlatma
Taban - Granit
Aksesuarlar - Altın Ayna Paslanmaz
Tutamak - 32 mm Krom Kulp

Спецификации

Боковые стены – Желтые, Декоративные из нержавеющей стали
Задняя стенка – Натуральный камень
Потолок – 3хмерное стекло + Светодиодное освещение
Пол – Компонентный Гранит + Стекло
Аксессуары - Зеркало из нержавеющей стали
Поручень - 32 мм Хромовые поручни

الخصائص

الجدران الجانبية
الجدار الخلفي
السقف
الأرضية
الاكسسوارات
الحافة العليا
ديكور أصفر غير قابل للصدأ
حجر طبيعي
كاميرا ثلاثية الأبعاد مع ليد
غرانيت
مرآة صفراء غير قابلة للصدأ
32مم كروم

Cabins / Cabine / Кабины / الكابينات

BEKASIA
E L E V A T O R

Asansör Kabini

Elevator Cabin

BEK-1600



BEKASIA
E L E V A T O R

Cabins / Cabine / Кабины / الكابينات

مشخصات

مشخصات
دیوار بغل - سنگ های طبیعی
دیوار پشت سر - مکمل آینه
صاف بالا - چراغ های LED
کف زمین - گرنیت
تجهیزات جانبی - آینه رنگ طلایی استیل خشدار
دست گیر - ۳۲ MM

Specifications

Side Walls - Divided Naturel Stone
Back Wall - Full Mirror
Ceiling - Naturel Stone + Led and Spot Lighting
Floor - Divided Granite with Glass and LED Lighting
Accessories - Golden Mirror Stainless
Handrail - 32mm Chrome Handrails

Özellikler

Yan Duvar - 18 mm Çok Parlak Laminant
Arka Duvar - Yarım Ayna
Tavan - Lazer Kesme, Led Aydınlatma
Taban - Granit
Aksesuarlar - Ayna Paslanmaz
Tutamak - 32 mm Krom Kulp

Спецификации

Боковые стены - Компонентное покрытие из природного камня
Задняя стенка - Зеркало в рост камень
Потолок - Природный камень + Светодиодное точечное освещение
Пол - Компонентный Гранит Стекло + Светодиодное освещение
Аксессуары - Желтое Зеркало из нержавеющей стали
Поручень - 32 мм Хромовые поручни

الخصائص

الجدان الجانبية حجر طبيعي مقطوع
الجدان الخلفي مرآة كاملة
السقف حجر طبيعي مع إضاءة ليد
الأرضية جرانيت زجاجي مقطوع مع إضاءة ليد
الاكسسوارات مرآة صفراء غير قابلة للصدأ
الحافة العليا 32مم كروم

Asansör Kabini

Elevator Cabin

BEK-1700

مشخصات

مشخصات
دیوار بغل - لمینات جلا دار 18mm
دیوار پشت سر - نیم آینه
صقف بالا - چراغ های led لاطری
کف زمین - گرنیت
تجهيزات جانبی - آینه استیل خش دار
دستگیر mm-

Specifications

Side Walls - 18mm Laminate Coating
Back Wall - Half Mirror
Ceiling - Laser Ceiling
Floor - Antibacterial PVC
Accessories - Mirror Stainless
Handrail - 32mm Chrome Handrails

Özellikler

Yan Duvar - 18 mm Çok Parlak Laminant
Arka Duvar - Yarım Ayna
Tavan - Lazer Kesme, Led Aydınlatma
Taban - Granit
Aksesuarlar - Ayna Paslanmaz
Tutamak - 32 mm Krom Kulp

Спецификации

Боковые стены - 18 мм ламинант
Задняя стенка - Зеркало в полроста
Потолок - Лазерный потолок
Пол - Антибактериальное покрытие из ПВХ
Аксессуары - Зеркало из нержавеющей стали
Поручень - 32 мм Хромовые поручни

الخصائص

الجدان الجانبية 18 مم لامينانت
الجدان الخلفي مرآة نصفية
السقف ليزر
الأرضية مضاد للبكتيريا
الاكسسوارات مرآة غير قابلة للصدأ
الحافة العليا 32مم كروم



Cabins / Cabine / Кабины / الكابينات

BEKASIA
E L E V A T O R

Asansör Kabini

Elevator Cabin

BEK-1800



مشخصات

مشخصات
دیوار بغل - لمینات جلادار 18mm
دیوار پشت سر - نیم آینه
صاف بالا - چراغ های led لاطری
کف زمین - گرنیت
تجهيزات جانبی - آینه استیل خش دار
دستگیر mm-

Specifications

Side Walls - Stainless Steel
Back Wall - Stainless Steel
Ceiling - Stainless Steel
Floor - Stainless Steel
Accessories - Shelf Panel

Özellikler

Yan Duvar - 18 mm Çok Parlak Laminant
Arka Duvar - Yarım Ayna
Tavan - Lazer Kesme, Led Aydınlatma
Taban - Granit
Aksesuarlar - Ayna Paslanmaz
Tutamak - 32 mm Krom Kulp

Спецификации

Боковые стены - Сатинированная нержавеющая сталь
Задняя стенка - Сатинированная нержавеющая сталь
Потолок - Сатинированная нержавеющая сталь
Пол - Сатинированная нержавеющая сталь
Аксессуары - Панель полки

الخصائص

الجدران الجانبية 304 ساتينا غير قابل للصدأ
الجدار الخلفي 304 ساتينا غير قابل للصدأ
السقف 304 ساتينا غير قابل للصدأ
الأرضية 304 ساتينا غير قابل للصدأ
الاكسسوارات رف نصفي
الحافة العليا

BEKASIA
E L E V A T O R

Cabins / Cabine / Кабины / الكابينات

Asansör Kabini

Elevator Cabin

BEK-1900

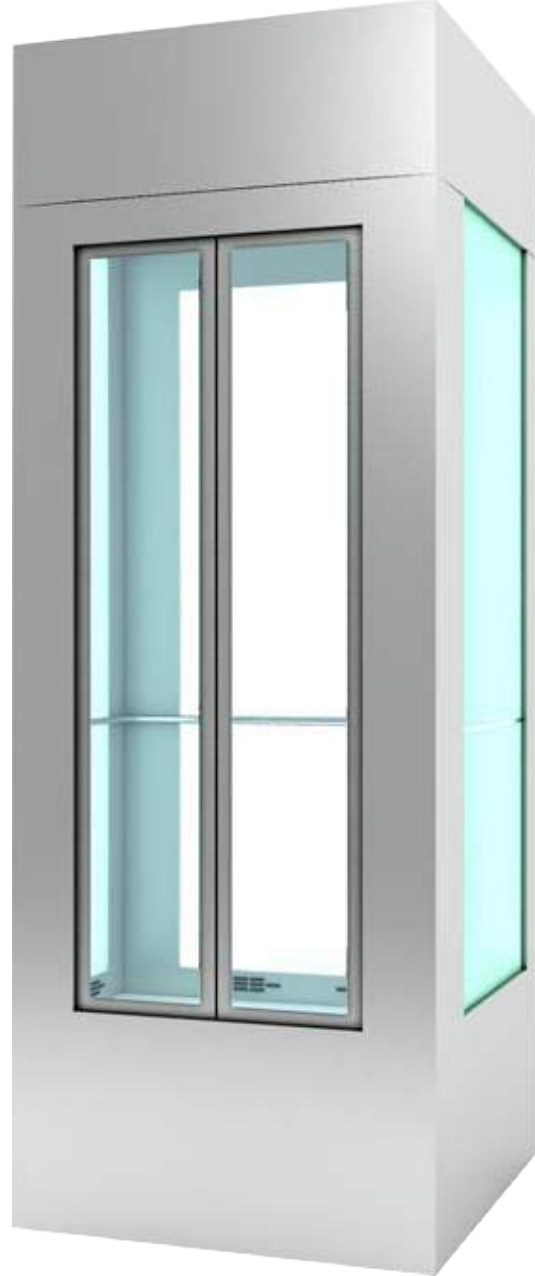

مشخصات

مشخصات
دیوار بغل - لمینات جلادار 18mm
دیوار پشت سر - نیم آینه
صقف بالا - چراغ های led لاظری
کف زمین - گرنیت
تجهيزات جانبی - آینه استیل خش دار
دستگیر mm-

Specifications

Side Walls - 18mm Divided Membrane Coating
Back Wall - Full Mirror
Ceiling - 3D Glass + LED Lighting
Floor - Granite
Accessories - Mirror Stainless
Handrail - 32mm Chrome Handrails

Özellikler

Yan Duvar - 18 mm Çok Parlak Laminant
Arka Duvar - Yarım Ayna
Tavan - Lazer Kesme, Led Aydınlatma
Taban - Granit
Aksesuarlar - Ayna Paslanmaz
Tutamak - 32 mm Krom Kulp

Спецификации

Боковые стены - 18 мм Частично мембранные
наложения
Задняя стенка - Зеркало в рост
Потолок - 3хмерное стекло + Светодиодное
освещение
Пол - Гранит
Аксессуары - Зеркало из нержавеющей
Поручень - 32 мм Хромовые поручни

الخصائص

الجدان الجانبية
الجدان الخلفي
السقف
الأرضية
الاكسسوارات
الحافة العليا
18 مم ميران مقطع
مرآة كاملة
كاميرا ثلاثية الأبعاد مع اضاءة
ليد
غرانيت
مرآة غير قابلة للصدأ
32مم كروم

Cabins / Cabine / Кабины / الكابينات

BEKASIA
E L E V A T O R

Asansör Kabini

Elevator Cabin

BEK-2000



مشخصات

مشخصات
دیوار بغل - لمینات جلدار 18mm
دیوار پشت سر - نیم آینه
صفه بالا - چراغ های led لاطری
کف زمین - گرنیت
تجهيزات جانبی - آینه استیل خش دار
دستگیر mm-

Specifications

Side Walls - 18mm Divided Membrane Coating
Back Wall - Full mirror
Ceiling - 3D Glass + LED Lighting
Floor - Granite
Accessories - Mirror Stainless
Handrail - 32mm Chrome Handrails

Caractéristiques

Revêtement de Côtés - Membrane divisé 18 mm
Revêtement arrière - Miroir Pleine Hauteur
Plafond - Verre 3D + Eclairage LED
Accessoires - Miroir inoxydable
Rampes - Rampe chromé 32mm

Спецификации

Боковые стены - 18 мм Частично мембранные
наложения
Задняя стенка - Зеркало в рост
Потолок - 3хмерное стекло + Светодиодное
освещение
Пол - Гранит
Аксессуары - Зеркало из нержавеющей
Поручень - 32 мм Хромовые поручни

الخصائص

الجدران الجانبية 18 مم ميران مقطع
الجدار الخلفي مرآة كاملة
السقف كاميرا ثلاثية الأبعاد مع إضاءة
ليد
الأرضية غرانيت
الاكسسوارات مرآة غير قابلة للصدأ
الحافة العليا 32مم كروم

BEKASIA
E L E V A T O R

Cabins / Cabine / Кабины / الكابينات

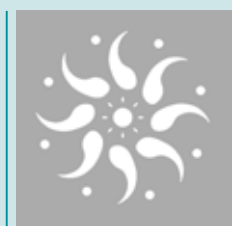

[VTA -101]



[VTA -102]



[VTA -103]

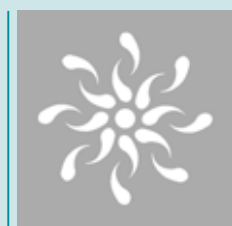

[VTA -104]

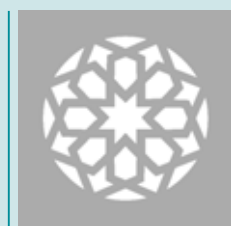

[VTA -105]

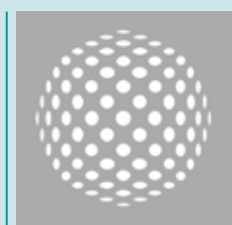

[VTA -106]

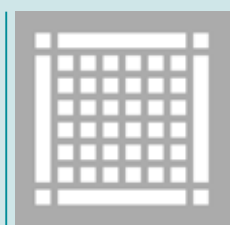

[VTA -107]



[VTA -108]

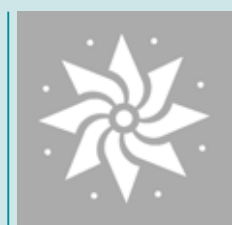

[VTA -109]

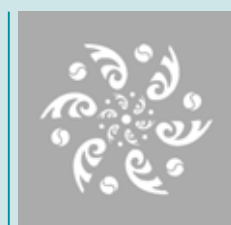

[VTA -110]

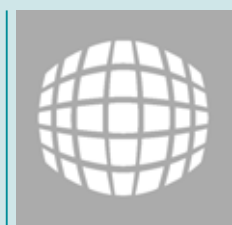

[VTA -111]

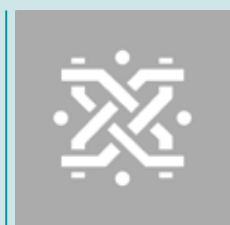

[VTA -112]

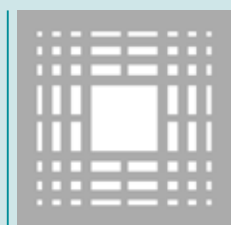

[VTA -113]

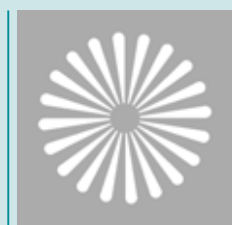

[VTA -114]

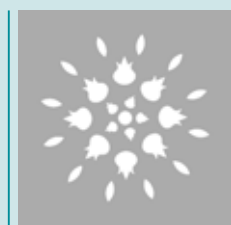

[VTA -115]

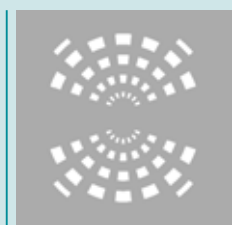

[VTA -116]

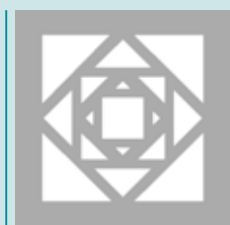

[VTA -117]

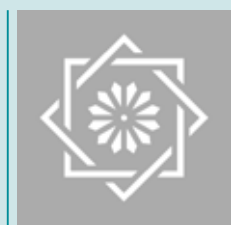

[VTA -118]

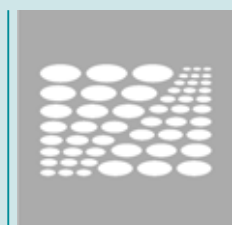

[VTA -119]

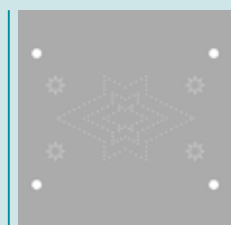

[VTA -120]



[VTB -101]

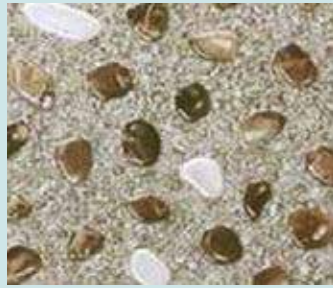

[VTB -102]

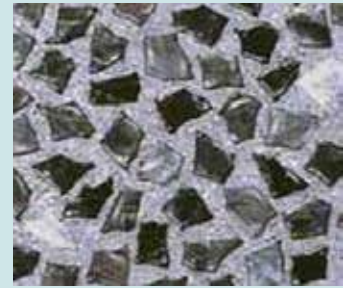

[VTB -103]



[VTB -104]

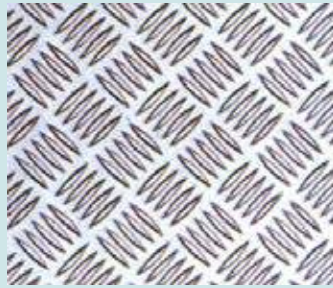

[VTB -105]



[VTB -106]



[VTB -107]



[VTB -108]



[VTB -109]



[VTB -110]



[VTB -111]

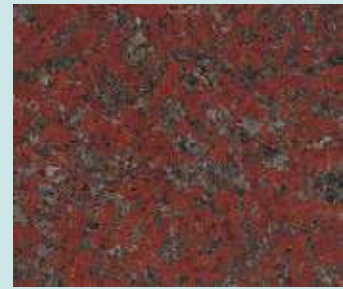

[VTB -112]



[VLK -101]



[VLK -102]



[VLK -103]



[VLK -104]

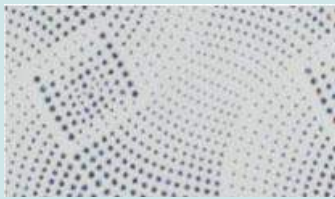

[VLK -105]



[VLK -106]



[VLK -107]



[VLK -108]



[VLK -109]



[VLK -110]



[VLK -111]



[VLK -112]



[VLK -113]



[VLK -114]



[VLK -115]



[VLK -116]

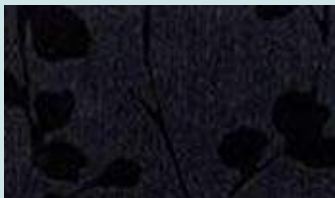

[VLK -117]



[VLK -118]



[VPK -101]

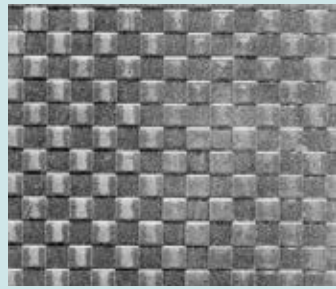

[VPK -102]

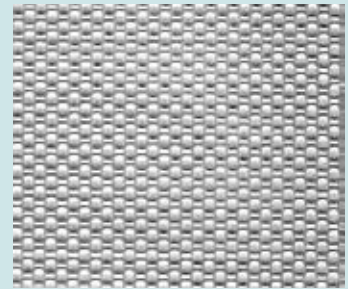

[VPK -103]



[VPK -104]



[VPK -105]

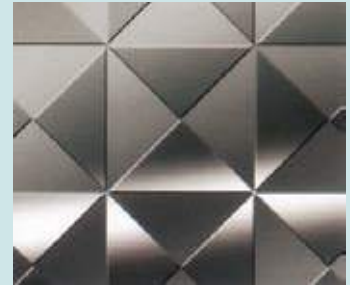

[VPK -106]



[VPK -107]



[VPK -108]



[VPK -109]



[VPK -110]



[VPK -111]



[VPK -112]

Kabin Süspansiyonları

Cabin Suspensions

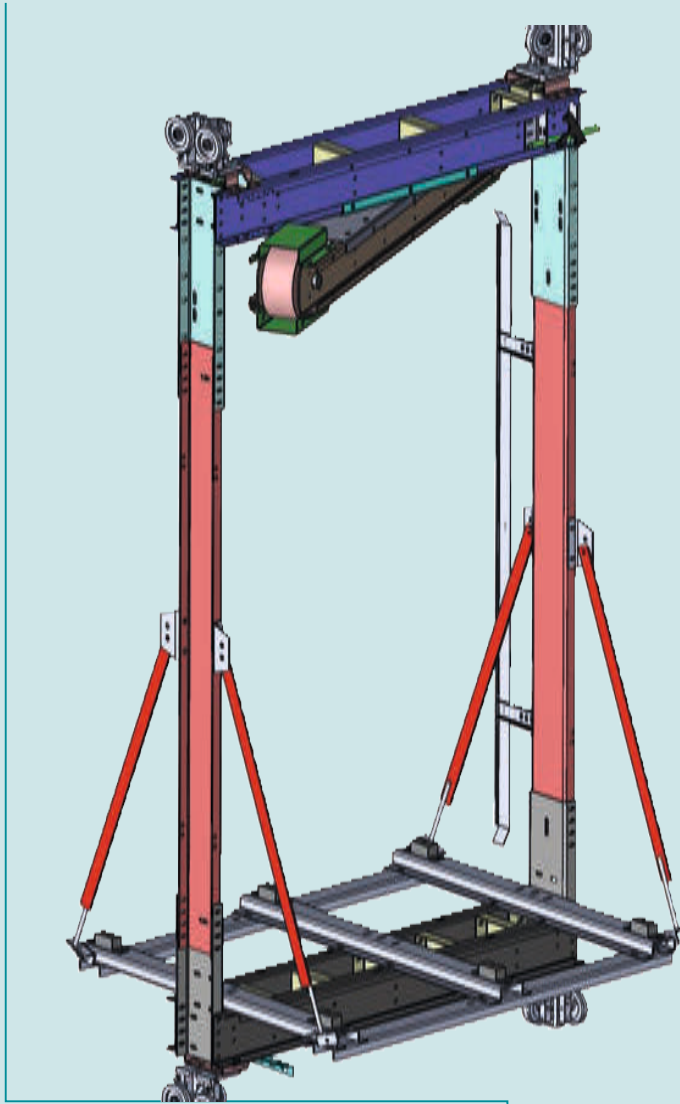

Cabin Frame
Structure De Cabine
КАРКАС КАБИНЫ
شريحة الكابينة



Counterweight Frame
Structure De Contrepoids
КАРКАС ПРОТИВОВЕСА
شريحة الثقل الآخر .

KUMANDA KARTLARI

Lift Controllers

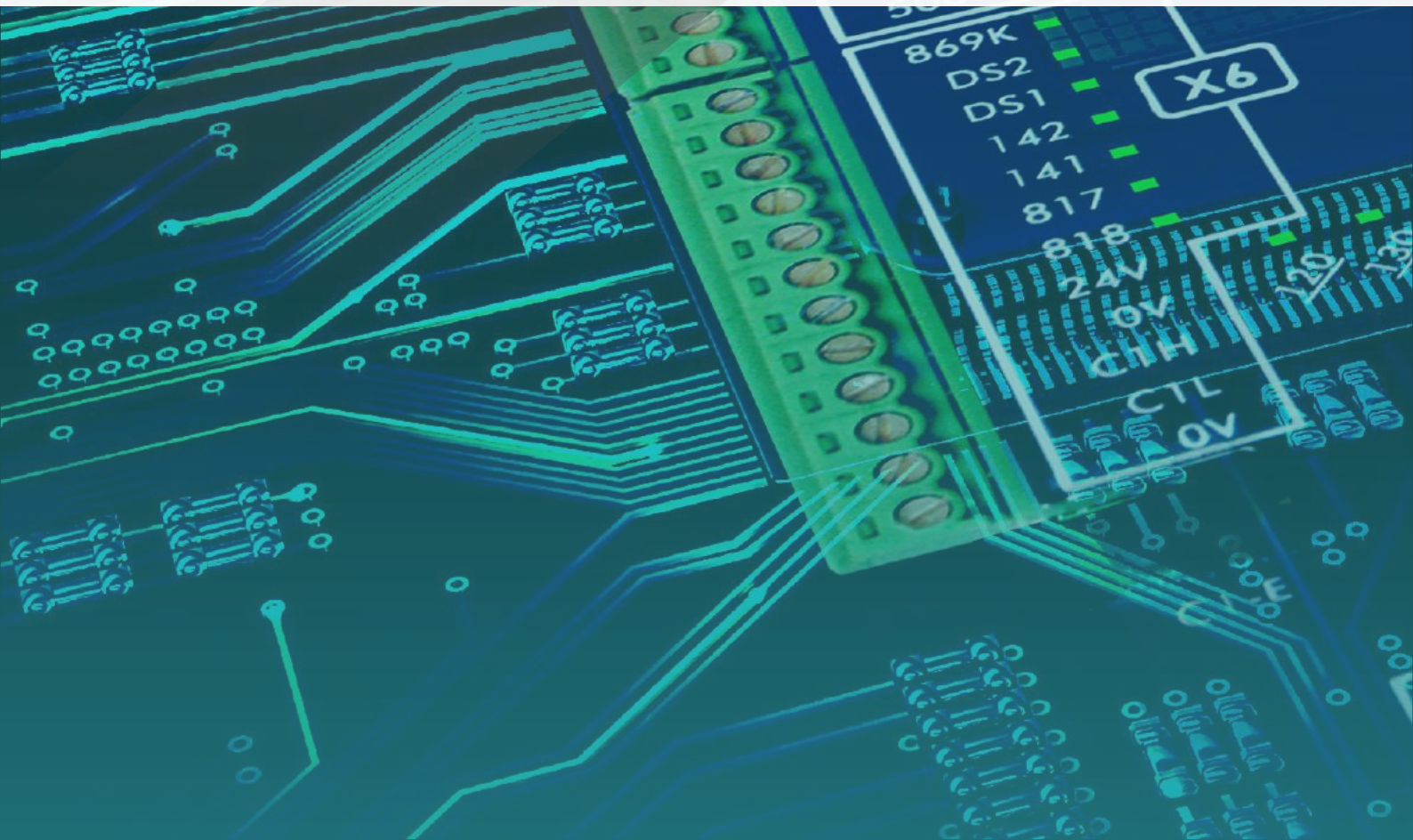

Mikosis G1



Standart	: EN 81-20/50
Tahrik Tipi	: Çift Hızlı-Hidrolik-VVVF (Senkron-Asenkron Motor)
Hız Kontrol	: CANOpen veya Analog çıkış seçimiyle EPC Kuyu Kopyalama ve Direkt Kata Erişim fonksiyonu
Seyir Hızı	: <1.6 m/s
Durak Sayısı	: 16 durak tek buton - 8 durak çift buton (Can-bus kat butonları ile 32 durak)
Kumanda Tipi	: Basit/Karışık Toplamalı/Aşağı Yön Seçici Toplamalı/Çift Yön Seçici Toplamalı

- Grup Kumanda Dupleks
- BYPASS muayene çalışma fonksiyonu
- Gerçek Zaman Saati
- Dahili Ortam Sıcaklık izleme ve kontrolü
- Son 64 adet detaylı hata kaydetme ve izleme
- Kabinle CANBus Seri Haberleşme
- Çok Fonksiyonlu Park Modları
- Yangın, Deprem fonksiyonu
- İtfaiyeci Servisi ve Vatman Çalışma
- Erken Kapı Açma ve Kapı Açık Seviyeleme

Standart	: EN 81-20/50
Drive Type	: 2-speed, Hydraulic, VVVF (synchronous/asynchronous motor)
Speed Control	: EPC Sha Copying and Direct Landing Position Control Feature with either CANOpen or Analogue Output selection
Travelling Speed	: 1.6 m/s
Number of Stops	: 16 stops one button or 8 stops two buttons [32 stops w/CANBus LCS landing stations]
Control Type	: Simple/Mixed Collective/Down-selective/Two-way selective collective Group Control Duplex

- Group Control Duplex
- BYPASS inspection operation function
- Real time clock
- Internal ambient temperature monitoring and control
- Detailed error recording and monitoring for the last 64 errors
- CANBus serial communication with car
- Multi-functional parking modes
- Fire and earthquake functions
- Firemen and preferential operations
- Door-opening in advance and releveling with opened doors

G1C KABİN SERİ HABERLEŞME KARTI
Car Serial Communication Board

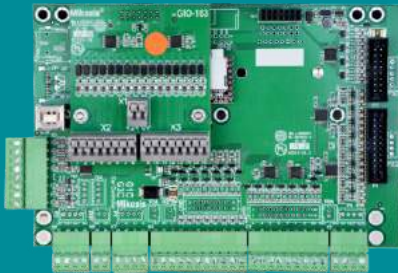

G1-DBB KAPI KÖPRÜLEME KARTI
Door Bridging Board



BYPASS TERTİBATI
BYPASS Device



ÖZELLİKLER

- Ince tasarım sayesinde az yer kaplama dar kapı kenarı yerleşimine imkan tanıma (130x270x40 mm)
- 17-30VDC kumanda sinyal besleme girişi
- 8-30VAc/Dc CPU besleme girişi
- 4 adet 250VAC emniyet devresi izleme girişleri
- 5 adet 24VDC/100mA NPN transistör çıkış, hız kontrol cihazı ve valf röleleri sürmek için
- 3 adet 24VDC/100mA NPN tranzistör çıkışı, Katta ve kapı köprüleme güvenlik fonksiyonları için
- 1 adet 0..5V/-5V..+5V/0..10V/-10V..+10V/4-20mA seçilebilir Analog çıkış, hız referansı çıkışı için
- Analog PTC girişi ile motor sıcaklığı izleme ve koruma fonksiyonu
- TTL/HTL Enkoder girişleri ve 5/12V Enkoder besleme çıkışı
- Kabin, Kuyudibi ve Pano için ayrı ayrı olmak üzere revizyon ve elektromekanik fren kumanda sinyal girişleri
- Kuyudibi revizyon sonrası normale dönüş için RESET anahtarı kumanda sinyali girişi
- 128x64 Grafik LCD Ekran / 7 adet tuş ile asansör parametre ve fonksiyonlarını kolayca izleme ve değiştirme
- Arızalı kapı kontak izleme ve normal çalışma koruma fonksiyonu
- UCMP (Istem dışı kabin hareketine karşı koruma) izleme fonksiyonu
- Acil durum elektrikli fren açtırma ve kabin aşırı hızlanma kontrolü
- Hidrolik asansörler için ikinci seviyeyeleme motoru sürüş fonksiyonu
- Enerji tasarrufu izleme ve kontrol fonksiyonu
- Motor veya hız regülatörü üzerinden kuyu kopyalama fonksiyonu
- 2 adet kat seviye şalteri ile seviyeyeleme fonksiyonu
- 1 adet USB/A Host portu üzerinden USB Flash bellek ile yazılım güncelleme, parametre ve hata listesi yedekleme/kopyalama
- 1 adet USB/B Device portu üzerinden PC ile izleme, kontrol ve yazılım güncelleme, parametre ve hata listesi yedekleme/kopyalama

FEATURES

- Possible to install on the "Landing Door-Frame" and "next-to-the Landing door" with slim-line design
- 17 - 30 VDC Control Signal Supply Input
- 8 - 30 VAC/DC CPU Supply Input
- 4 safety circuit monitoring inputs, rated at 250VAC
- 5 NPN-transistor outputs, rated at 24VDC/100mA: For driving speed-controller and valve relays
- 3 NPN-transistor outputs, rated at 24VDC/100mA: For safety functions of "at floor and door-bridging"
- 1 selectable analogue speed-reference output in the range of 0..5V/±5V/0..10V/±10V/4-20mA
- Motor temperature monitoring and protection function via analogue PTC input
- TTL/HTL encoder inputs and 5/12V encoder supply output
- Inspection and electromechanic brake control signal inputs for car, shaft-pit and control panel each
- RESET switch control signal input for returning to normal operation after shaft-pit inspection
- 128x64 graphic LCD display / Easy monitoring and change of li parameters and functions using a 7 push-button keypad
- Faulty-door contact monitoring and normal operation protection function
- UCMP (Unintended Car Movement Protection) monitoring function
- Emergency electrical brake release and car over-speed control
- Second-levelling-motor drive function for hydraulic lift
- Energy-saving monitoring and control functions
- Sha -copying function via motor or speed-regulator
- Levelling function with 2 floor-level-switches
- Firmware update, paramete and error list backup/copying using a USB flash memory stick via USB-A Host port
- Firmware update, parameter and error list backup/copying, monitoring, and control of li controller simply connecting PC unit to USB-B Device port.

G1C KABİN SERİ HABERLEŞME KARTI

- 2 adet kabin butonları giriş/çıkış kartı portu
- 2 adet kabin kapısı desteği (Sadece G1-RF kartı ile desteklenir)
- Kabin havalandırma fanı kontrolü
- İtfayeci Servisi ve Vatman Çalışma kumanda sinyal girişleri
- Kabin cihazları enerji tasarrufu uyku modu fonksiyonu ve çıkışı
- -9..39 durak için NPN segment çıkışları
- 6 bit PNP GRAY/BINARY kod display, yön oku, 2 adet gong çıkışları
- Kısa devre ve aşırı akım korumalı 12V acil durum aydınlatma çıkışı
- Sesli Anons MP3 desteği ve 1W hoparlör çıkışı
- Dahili Ortam Sıcaklık izleme ve kontrolü
- Dahili buzzer ile aşırı yük ve kabin kayıt kabulü sesli ikaz bildirir fonksiyonu
- BYPASS flash aydınlatma ve buzzer çıkış fonksiyonu

G1-DBB KAPI KÖPRÜLEME KARTI

- Güvenli kapı köprüleme fonksiyonu
- Olası donanım ve yazılım hatalarına karşı koruma

BYPASS TERTİBATI

- Durak ve kabin kapısını devre dışı bırakan (bypass) tertibatı; kapı kilitleme kontaklarının bakımı için durak ve kabin kapısını devre dışı bırakan (bypass eden) bir tertibattır.
- Normal çalışma ve köprülenen kapının ayrı ayrı bildirilmesi fonksiyonu

G1C SERIAL COMMUNICATION CAR CONTROLLER

- 2 ports for landing push-buttons input/output cards
- Two car-doors support (Supported only by G1-RF board)
- Car ventilation fan control
- Control signal inputs for firemen and preferential operations
- Energy-saving sleep-mode function/output for car devices
- NPN segment outputs for -9, ... ,39 stops
- 6 bit PNP GRAY/BINARY code display, direction arrow, two gong outputs
- Short-circuit and over-current protected 12V emergency lighting output
- Audible announce MP3 support and 1W speaker output
- Internal ambient temperature monitoring and control
- Audible warning signal for car over-load and car call acceptance with use of an internal buzzer
- Flashing light and audible warning buzzer outputs for BYPASS functionality

G1-DBB DOOR BRIDGING BOARD

- Safe door-bridging function
- Protection against any probable hardware and firmware faults

BYPASS DEVICE

- Landing and car door bypass device is provided for maintenance of contacts of the landing door, car door and door locking.
- Notification of normal and bridged doors's Bypass status seperately to the lift controller

Mikosis G3



Standart	: EN 81-20/50
Tahrik Tipi	: Çift Hızlı-Hidrolik-VVVF (Senkron-Asenkron Motor)
Hız Kontrol	: CANOpen veya Analog çıkış seçimiyle EPC Kuyu Kopyalama ve Direkt Kata Erişim fonksiyonu
Seyir Hızı	: <4.0 m/s
Durak Sayısı	: 64 durak tek buton / çift buton
Kumanda Tipi	: Basit/Karışık Toplamalı/Aşağı Yön Seçici Toplamalı/Çift Yön Seçici Toplamalı

- Grup Kumanda Quadrupleks (4'lü grup kumanda)
- BYPASS muayene çalışma fonksiyonu
- Gerçek Zaman Saati
- Dahili Ortam Sıcaklık izleme ve kontrolü
- Son 64 adet detaylı hata kaydetme ve izleme
- Kabinle CANBus Seri Haberleşme
- Çok Fonksiyonlu Park Modları
- Yangın, Deprem fonksiyonu
- İtfaiyeci Servisi ve Vatman Çalışma
- Erken Kapı Açma ve Kapı Açık Seviyeleme

Standart	: EN 81-20/50
Drive Type	: 2-speed, Hydraulic, VVVF (synchronous/ asynchronous motor)
Speed Control	: EPC Sha Copying and Direct Landing Position Control Feature with either CANOpen or Analogue Output selection
Travelling Speed	: 4.0 m/s
Number of Stops	: 64 stops one button or / two buttons
Control Type	: Simple/Mixed Collective/Down-selective/Two-way selective collective Group Control Dublex

- Group Control Quadrupleks
- BYPASS inspection operation function
- Real time clock
- Internal ambient temperature monitoring and control
- Detailed error recording and monitoring for the last 64 errors
- CANBus serial communication with car
- Multi-functional parking modes
- Fire and earthquake functions
- Firemen and preferential operations
- Door-opening in advance and releveling with opened doors

G3C KABİN SERİ HABERLEŞME KARTI
Car Serial Communication Board

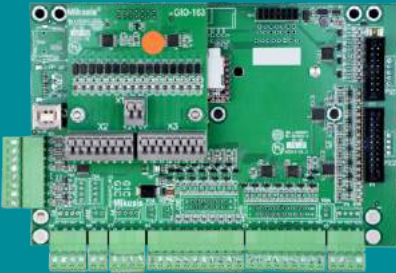

G1-DBB KAPI KÖPRÜLEME KARTI
Door Bridging Board



BYPASS TERTİBATI
BYPASS Device



ÖZELLİKLER

- İnce tasarım sayesinde az yer kaplama dar kapı kenarı yerleşimine imkan tanıma (130x201x40 mm)
 - 17-30VDC kumanda sinyal besleme girişi
 - 8-30VAc/Dc CPU besleme girişi
 - 4 adet 250VAC emniyet devresi izleme girişleri
 - 5 adet 24VDC/100mA NPN transistör çıkışı, hız kontrol cihazı ve valf röleleri sürmek için
 - 3 adet 24VDC/100mA NPN transistör çıkışı, katta ve kapı köprüleme güvenlik fonksiyonları için
 - 1 adet 0..5V/-5V..+5V/0..10V/-10V..+10V/4-20mA seçilebilir Analog çıkış, hız referansı çıkışı için
 - Analog PTC girişi ile motor sıcaklığı izleme ve koruma fonksiyonu
 - TTL /HTL Enkoder girişleri ve 5/12V Enkoder besleme çıkışı
 - Kabin, Kuyudibi ve Pano için ayrı ayrı revizyon ve elektromekanik fren kumanda sinyal girişleri
 - Kuyudibi revizyon sonrası normale dönü için RESET anahtar kumanda sinyali girişi
 - 128x64 Grafik LCD Ekran / 7 adet tuş ile asansör parametre ve fonksiyonlarını kolayca izleme ve değiştirme
 - Arızalı kapı kontak izleme ve normal çalışma koruma fonksiyonu
 - UCMP (Istem dışı kabin hareketine karşı koruma) izleme fonksiyonu
 - Acil durum elektrikli fren açtırma ve kabin aşırı hızlanma kontrolü
 - Hidrolik asansörler için ikinci seviyeleme motoru sürüş fonksiyonu
 - Enerji tasarrufu izleme ve kontrol fonksiyonu
 - Motor veya hız regülatörü üzerinden kuyu kopyalama fonksiyonu
 - 2 adet kat seviye şalteri ile seviyeleme fonksiyonu
 - 1 adet USB/A Host portu üzerinden USB Flash bellek ile yazılım güncelleme, parametre ve hata listesi yedekleme/kopyalama
 - 1 adet USB/B Device portu üzerinden PC ile izleme, kontrol ve yazılım güncelleme, parametre ve hata listesi yedekleme/kopyalama
 - 1 adet 10/100Mb RJ45 Ethernet portu ile Asansör Uzaktan Erişim ve izleme, kontrol ve yazılım güncelleme, parametre ve hata listesi yedekleme/kopyalama
 - 1 adet USB Mini/B konektörü ile opsiyonel taşınabilir el terminali
- 1 adet yüksek hızlı seri haberleşme portu opsiyonel genişleme kartları için
 - 1 adet dokunmatik TFT/LCD portu (Opsiyon)
 - Arttırılabilir dahili FLASH ve SRAM bellek ile anlık kayıt tutma ile gelişmiş arıza analiz fonksiyonu (Opsiyon)
 - CANOpen mutlak kuyu okuyucu ile hassas kuyu kopyalama ve seviyeleme fonksiyonu (Opsiyon)

FEATURES

- Possible to install on the "Landing Door-Frame" and "next-to-the Landing door" with slim-line design
 - 17 - 30 VDC Control Signal Supply Input
 - 8 - 30 VAC/DC CPU Supply Input
 - 4 safety circuit monitoring inputs, rated at 250VAC
 - 5 NPN-transistor outputs, rated at 24VDC/100mA: For driving speed-controller and valve relays
 - 3 NPN-transistor outputs, rated at 24VDC/100mA: For safety functions of "at floor and door-bridging"
 - 1 selectable analogue speed-reference output in the range of 0..5V/±5V/0..10V/±10V/4-20mA
 - Motor temperature monitoring and protection function via analogue PTC input
 - TTL/HTL encoder inputs and 5/12V encoder supply output
 - Inspection and electromechanic brake control signal inputs for car, shaft-pit and control panel each
 - RESET switch control signal input for returning to normal operation after shaft-pit inspection
 - 128x64 graphic LCD display / Easy monitoring and change of lift parameters and functions using a 7 push-button keypad
 - Faulty-door contact monitoring and normal operation protection function
 - UCMP (Unintended Car Movement Protection) monitoring function
 - Emergency electrical brake release and car over-speed control
 - Second-levelling-motor drive function for hydraulic lifts
 - Energy-saving monitoring and control functions
 - Shaft-copying function via motor or speed-regulator
 - Levelling function with 2 floor-level-switches
 - Firmware update, parameter and error list backup/copying using a USB flash memory stick via USB-A Host port
 - Firmware update, parameter and error list backup/copying, monitoring, and control of lift controller simply connecting PC unit to USB-B Device port.
 - Remote access to lift via 10/100Mb RJ45 Ethernet port. Monitoring, control and
- Optional hand-terminal connection via USB Mini/B connector
 - High-speed serial communication port for optional expansion cards
 - Connection port for optional touch-screen TFT/LCD (1 unit) (Option)
 - Instant record holding feature by means of internal FLASH and SRAM memory, advanced error analysis function (Option)
 - Precise shaft-copying and levelling function using CANOpen absolute shaft reader (Option)

G3C KABİN SERİ HABERLEŞME KARTI

- 2 adet kabin butonları giriş/çıkış kartı portu
- 2 adet kabin kapısı desteği (Sadece G1-RF kartı desteklenir)
- Kabin havalandırma fanı kontrolü
- İtfayeci Servisi ve Vatman Çalışma kumanda sinyal girişleri
- Kabin cihazları enerji tasarrufu uyku modu fonksiyonu ve çıkışı
- -9..39 durak için NPN segment çıkışları
- 6 bit PNP GRAY/BINARY kod display, yön oku, 2 adet gong çıkışları
- Kısa devre ve aşırı akım korumalı 12V acil durum aydınlatma çıkışı
- Sesli Anons MP3 desteği ve 1W hoparlör çıkışı
- Dahili Ortam Sıcaklık izleme ve kontrolü
- Dahili buzzer ile aşırı yük ve kabin kayıt kabulü sesli ikaz bildiri fonksiyonu
- BYPAS flash aydınlatma ve buzzer çıkış fonksiyonu
- Mutlak basınç izleme ve kabin gerçek pozisyonu belirleme fonksiyonu
- 3 eksenli ivme ölçer ile gerçek kabin hızı ölçümü ve aşırı hızlanmaya karşı koruma ve seyir konforu analiz fonksiyonu
- Yük hücresi girişi ile hassas kabin yükü ölçüm fonksiyonu
- 2 adet RFID okuyucu ile asansör güvenlik sistemi fonksiyonu
- SD Flash bellek yuvası (Opsiyon)
- 1 adet dokunmatik TFT/LCD portu (Opsiyon)

G3C SERIAL COMMUNICATION CAR CONTROLLER

- 2 ports for landing push-buttons input/output cards
- Two car-doors support (Supported only by G1-RF board)
- Car ventilation fan control
- Control signal inputs for firemen and preferential operations
- Energy-saving sleep-mode function/output for car devices
- NPN segment outputs for -9, ... ,39 stops
- 6 bit PNP GRAY/BINARY code display, direction arrow, two gong outputs
- Short-circuit and over-current protected 12V emergency lighting output
- Audible announce MP3 support and 1W speaker output
- Internal ambient temperature monitoring and control
- Audible warning signal for car over-load and car call acceptance with use of an internal buzzer
- Flashing light and audible warning buzzer outputs for BYPASS functionality
- Absolute pressure monitoring and car real position determination function
- Real car travelling speed measurement by means of 3-axes accelerometer, protection against over-speed, and travelling comfort analysis function
- Precise car load measurement function via load-cell input
- Li security system functionality via two RFID reader ports
- SD Flash memory socket (Option)
- One touch-screen TFT/LCD ports (Option)

BEKASIA
E L E V A T O R

**GELİŞEN TEKNOLOJİYE
AYAK UYDURMAK
GEREK !**

"Çünkü; güvenliğiniz bizim elimizde."

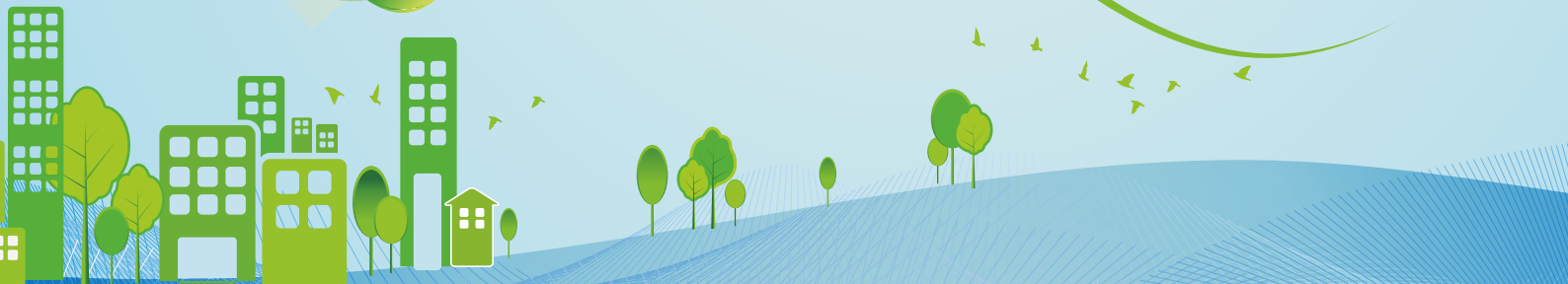



BEKASIA
E L E V A T O R

KUMANDA PANOLARI

Lift Controllers

Mikosis G1

Standart : EN 81-20/50
Tahrik Tipi : Çift Hızlı-Hidrolik-VVVF (1,6 m/sn)
Durak Sayısı : 16 durak
Grup Kumanda : Dupleks

- Kabinle CANBus Seri Haberleşme
- Gerçek zaman saati
- Erken Kapı açma / Kapı Açık seviyeleme
- Çok Fonksiyonlu Park Modları
- Yangın, Deprem fonksiyonu
- İtfayeci Servisi
- Vatman çalışması
- Dahili Ortam Sıcaklık Kontrolü
- Son 64 adet detaylı hata kaydetme ve izleme

Standart : EN 81-20/50
Drive type : Two Speed-Hydraulic VVVF (1,6 m/s)
Floor number : 16 stops
Group control : Dublex

- Car controller with CANBus Communication
- Real Time Clock
- Releveling with opened doors and opening in advance.
- Multifunctional Parking Modes
- Fire, Earthquake Modes Firemen Operation
- VIP Service
- Internal Temperature Control
- Detailed error recording and monitoring for the last 64 errors



Mikosis G3

Standart : EN 81-20/50
Tahrik Tipi : Çift Hızlı-Hidrolik-VVVF (4 m/sn)
Durak Sayısı : 64 durak
Grup Kumanda : Quadrupeks

- Kabinle CANBus Seri Haberleşme
- Gerçek zaman saati
- Erken Kapı açma / Kapı Açık seviyeleme
- Çok Fonksiyonlu Park Modları
- Yangın, Deprem fonksiyonu
- İtfayeci Servisi
- Vatman çalışma
- Dahili Ortam Sıcaklık Kontrolü
- Son 64 adet detaylı hata kaydetme ve izleme

Standart : EN 81-20/50
Drive type : Two Speed-Hydraulic VVVF (4 m/s)
Floor number : 64 stops
Group control : Quadrupeks

- Car controller with CANBus Communication
- Real Time Clock
- Releveling with opened doors and opening in advance.
- Multifunctional Parking Modes
- Fire, Earthquake Modes Firemen Operation
- VIP Service
- Internal Temperture Control
- Detailed error recording and monitoring for the last 64 errors



Regeneratif Asansör Kumanda Sistemleri

Regenerative Lift Control Systems



Modern Asansör Kumanda Sistemleri ile Enerji Tasarrufu ve Enerji Verimliliği

Energy Saving and Energy Efficiency by Modern Lift Control Systems

Geleneksel Asansör Kumanda Sistemlerinde;

Yükün ataletinden kaynaklanan hareket enerjisinin elektrik enerjisi olarak üretildiği regeneratif seyir esnasında ortaya çıkan frenleme enerjisi, sürücünün DC barına bağlı rheostatik direnç üzerinde atıl ısı olarak harcanır ve sonuçta önemli miktarda bir enerji kaybı ortaya çıkar.

Modern Asansör Kumanda Sistemlerinde;

Regeneratif seyir esnasında ortaya çıkan frenleme enerjisi, çift-yönlü güç akışına imkan sağlayan AFE200 REGEN SÜRÜCÜ üzerinden şebekeye geri basılmaktadır. Böylece, önemli miktarda atıl enerji elektrik enerjisi formunda geri kazanılmaktadır. Uyku-Modu (Sleep-Mode) iletim özelliğine sahip Mikosis Asansör Kumanda Sistemi ile asansörlerde toplam enerji verimliliğine önemli miktarda katkı sağlanabilmektedir.

In the traditional Lift Control Systems;

The braking energy, arisen during the regenerative travel of the traction motor by which motion energy resulting from the load inertia is generated as electric energy, is dissipated as heat energy on the rheostatic resistor connected to the DC link of the drive. Consequently, a significant amount of energy is lost (waste of energy).

In the modern Li Control Systems;

The braking energy, arisen during the regenerative travel of the traction motor by which motion energy resulting from the load inertia is generated as electric energy, is recovered and fed-back to the grid through AFE200 REGEN DRIVE allowing bidirectional power flow. Consequently, a significant amount of energy is gained in the form of useful electric energy. Mikosis Lift Control System with sleep-mode operation feature could provide a significant contribution to the total energy efficiency of the complete lift installation.

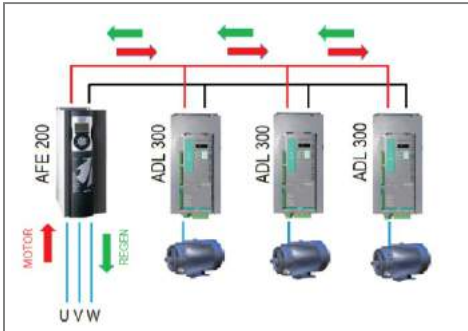

AFE200 + ADL300 Regen İnverter Sürücü Sistemi
AFE200 + ADL300 Regen Lift Drive System

İŞLETME MASRAFLARININ AZALTILMASI

Asansör sektöründe rejeneratif sistemlerin kullanımı, Bina Otomasyonu ve binaların Enerji Verimliliği söz konusu olduğunda her geçen gün daha çok talep edilen yararları sağlamaktadır. Trafik profillerinin bu seçimi desteklediği durumlarda, rejeneratif üniteli sistem gerek ekonomi gerekse teknik açıdan avantajların bir araya getirilmesini mümkün kılar. İşleme ilkesi basittir: boş kabin yükseldiğinde veya tam yüklü kabin aşağıya indiğinde mekanik sistem, kabinin yükü tarafından "çekildiğinden" elektrik motorunun elektrik enerjisine dönüştürdüğü potansiyel enerjiyi oluşturur.

TEMİZ ENERJİ

Rejeneratif ünite motor tarafından oluşturulan elektrik enerjisini, harmonik içeriği olmayan (THD <4%) "temiz" enerjiye dönüştürür ve bu şekilde binada mevcut olan bütün elektrikli aparatların bu enerjiyi yeniden kullanmalarını mümkün kılar.

DAHA VERİMLİ BİNALAR

Bu çözüm tipi, frenleme direncinin kullanılması artık gerekli olmadığından montaj alanlarını küçültmekle birlikte, büyük bir kısmı iklimlendirme, soğutma aparatları, pompalama sistemleri ve asansörler tarafından kullanılan bina enerji tüketimini azaltır.



ECO



Asansör Kumanda Sistemi ve Kuyu Bileşenleri

Lift Control Systems and Shaft Components

EN 81-20/50

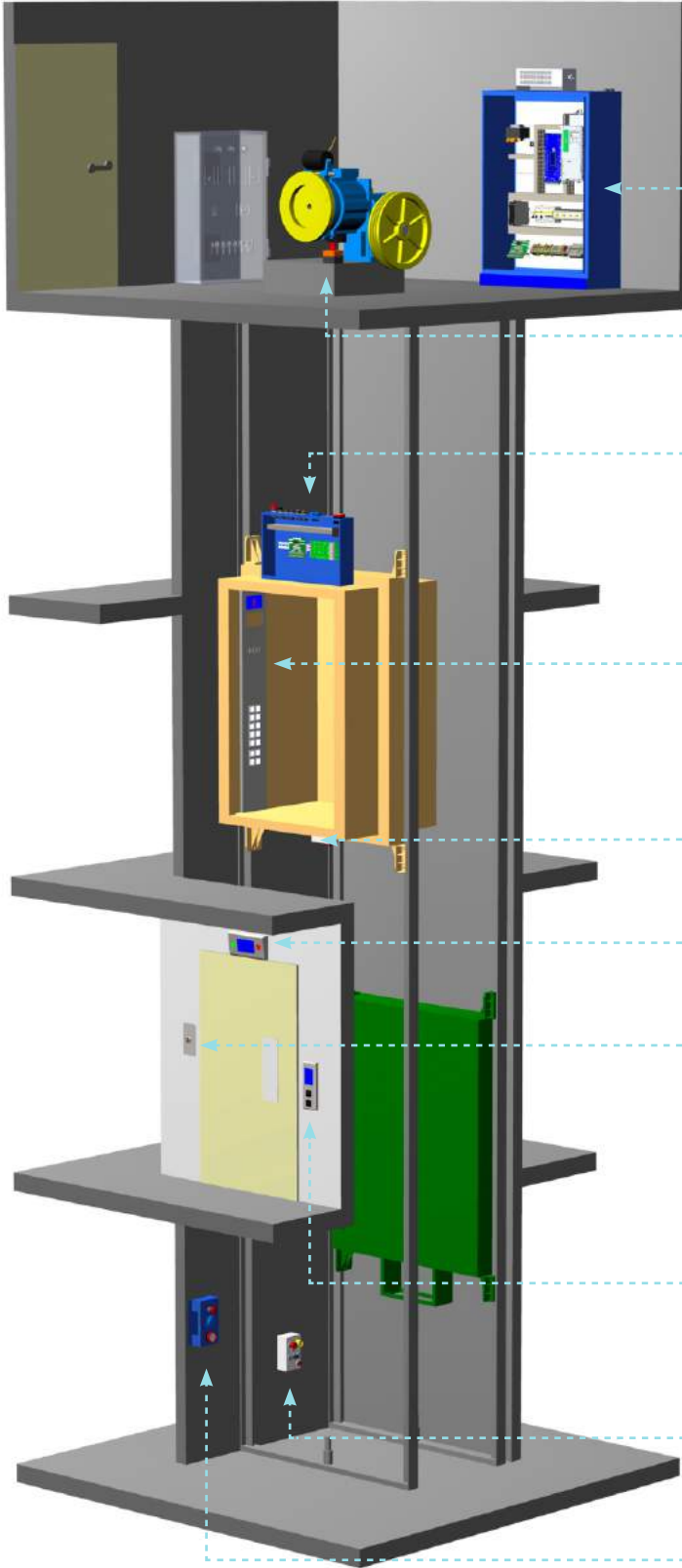

Kumanda Panosu
Control Panel



Durdurma Anahtarı
Emergency Stop



Kabin Üzeri Revizyon Seti
Car-Roof Inspection Box



Kabin Butonyeri
Car Operating Button Panel (COP)



Bypass Tertibat Sireni
Bypass Siren



Kapı Üstü Gösterge
Overdoor Indicator



Reset Anahtarı
Electrical Reset Switch



Durdurma ve Kuyu Ayd. Butonu
Emergency Stop and Shaft Lighting Button Box



Kat Butonyeri
Landing Operating Button Panel (LOPs)



Muayene Kumanda İstasyonu
Inspection Control Station (Pit)



**Kuyu Dibi Tesilat Kutusu/
Dahili Muayene Kumanda İstasyonu**
Electric Equipment Box in the Pit/
Inspection Control Station (Pit)



Hazır Tesisat Çözümleri

Pre-Cut and Pre-Wired Electrical Connection Solutions

HAZIR KUYU VE KABİN TESİSATI

Easy Connect for Elevator Shaft and Car

Hızlı ve Hatasız Bağlantı İçin *For quick and correct connection*

Hazır Tesisat grubunda; kumanda panosu-makina dairesi-asansör kuyusu-fleksibıl kabloları konnektörlü olarak yer almaktadır. Komple Hazır Tesisat grubu ile, tesisattaki kablo ve bağlantı karışıklığına son verilmiştir, bağlantılar kolaylaştırılmıştır. Sistemin kurulum zamanı en aza indirilmiştir. Hazır Tesisat grubu ile sistem kurulum bağlantı hataları olmayacak ve daha güvenli hale gelecektir.

Included in ready installation group: control panel - machine room - elevator shaft- flexible as connector cables are included. Ready Installation Complete group with plug in the installation and connection cable end to the installation and connection cable end to the complexity of the links easier. The system setup time is minimized. Ready for connection to the system setup with a group of installation errors and more secure, you still will not be.

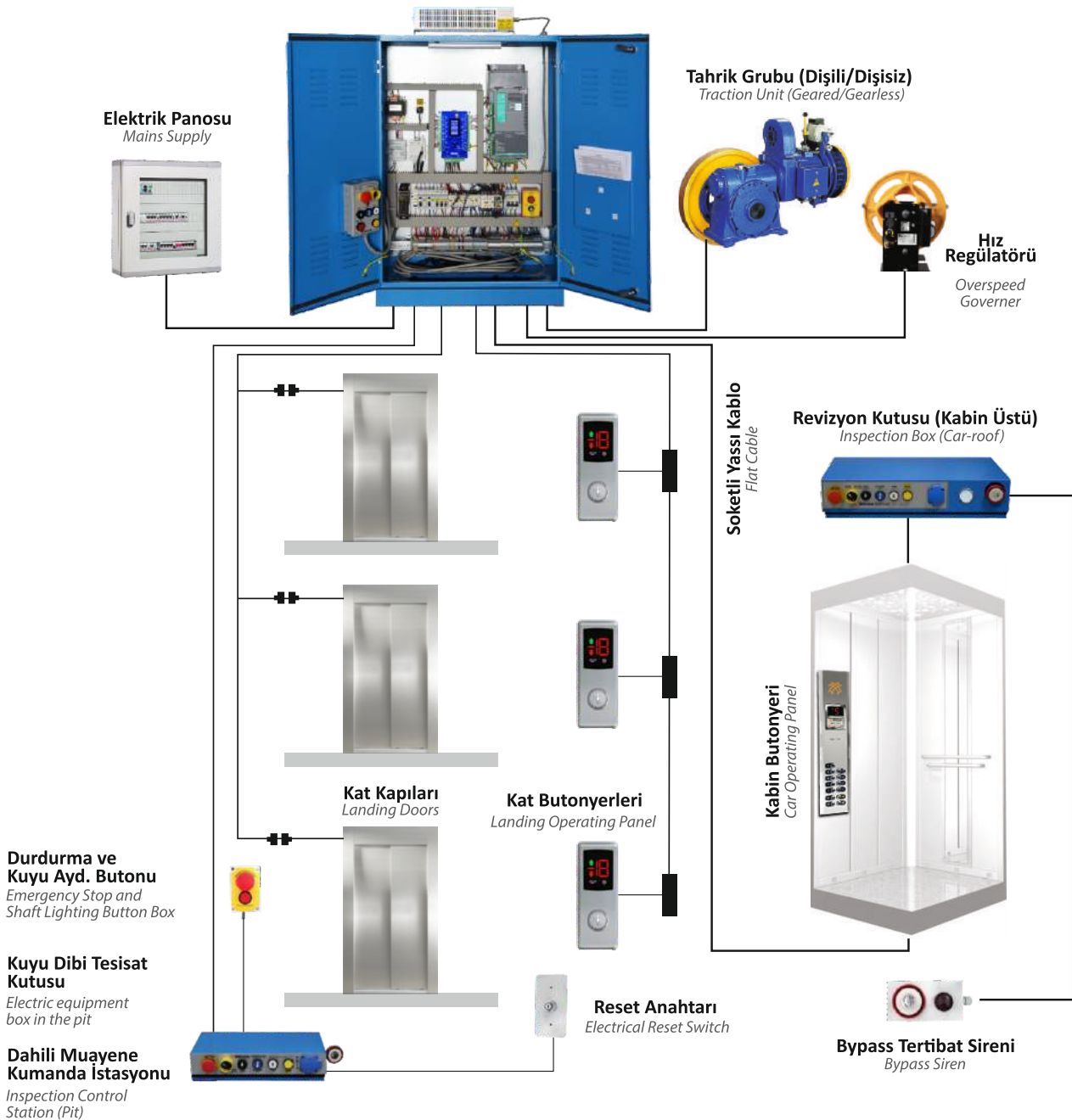

BEKASIA
E L E V A T O R

İM O D E R N
İ Y E N İ L İ K Ç İ

BUTONLAR
Pushbuttons

Butonlar

Push Buttons

K MODEL

- Paslanmaz çelik çerçeve
- Önden montaj, somun ile sabitleme
- Braille alfabe (kabartmalı sembol)
- Paslanmaz Çelik Yüzey
- Led Işıklandırılmış Çerçeve ve Rakamlar
- Kolay Montaj
- Buzer Opsiyonu

- *Stainless steel ABS bezel*
- *Frontal mount, fastening by nut*
- *Braille script (raised symbol)*
- *Stainless steel push plate*
- *LED illuminated figure and surroundings*
- *Easy assembly*
- *Buzzer Options*
- *Dual Color Led Options*



K11



K11



K11



K12



K12



K12

S MODEL

- Paslanmaz çelik çerçeve
- Önden montaj, somun ile sabitleme
- Braille alfabe (kabartmalı sembol)
- Led Işıklandırılmış Çerçeve ve Rakamlar
- Kolay Montaj
- Buzer Opsiyonu

- *Stainless steel ABS bezel*
- *Frontal mount, fastening by nut*
- *Braille script (raised symbol)*
- *LED illuminated figure and surroundings*
- *Easy assembly*
- *Buzzer Options*
- *Dual Color Led Options*



S11



S12



S13



S11



S12



S13

R MODEL

- Krom kaplama ABS çerçeve
- Farklı renk çerçeve alternatifi
- Paslanmaz çelik yüzey
- Led ışıklandırılmış çerçeve ve rakamlar
- Braille alfabe (kabartma sembol)
- Kolay montaj
- Buzer Opsiyonu
- Çift Led Seçeneği
- *Stainless steel ABS bezel*
- *Various color frame options*
- *Stainless steel push plate*
- *LED illuminated figure and surroundings*
- *Braille script (raised symbol)*
- *Easy assembly*
- *Buzer Options*
- *Two Leds Options*

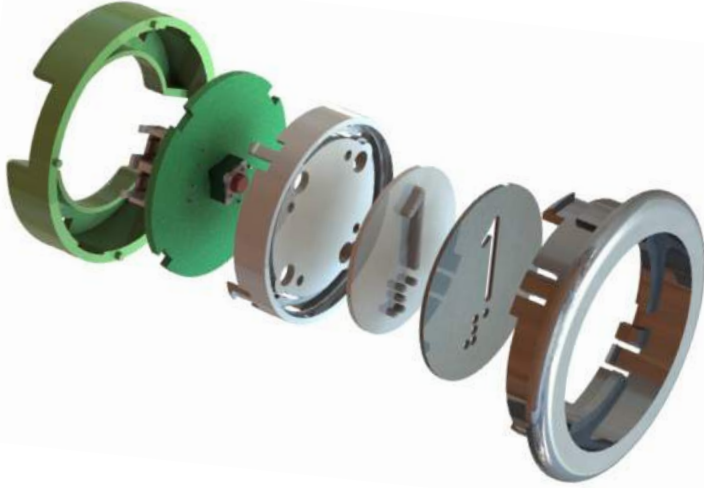

ÇİFT LEDLİ BUTON MODELLERİ Two-Leds Button Models

**Buton Aydınlatma
Led Rengi**
Button Lighting
LED color



Beyaz/White



Kırmızı/Red



Mavi/Blue



Kırmızı/Red

**Buton Kayıt Alma
Rengi**
Button Call-Register
LED color



Kırmızı/Red



Yeşil/Green



Kırmızı/Red



Beyaz/White

Gösterge Modelleri

Display Models

CANBUS BAĞLANTILI KABİN GÖSTERGELERİ

Canbus Connected Car
Operating Display Models



7" TFT



10" TFT



15" TFT



CDA03



LCD 114x74 GRAFİK

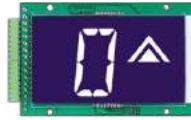

LCD 110x60
ALFANUMERİK



DOTMATRIX 65 MM

CANBUS BAĞLANTILI KAT GÖSTERGELERİ

Canbus Connected
Landing Operating Display
Models



LCS-K



LCS-Y



LCS-B



LCS-M



LCM80-K



LCM80-Y



LCM80-B



LCM80-M



LCM160-B



LCM160-K



LCM160-M

LCS ve LCM Kat Gösterge Özellikleri

- Otomatik kat tanıma (adresleme) özelliği
- Bekleme modu ve uyku modu sayesinde AKILLI ENERJİ TASARRUF özelliği.
- Kullanılan Parlak Ledler Sayesinde yüksek okunabilirlik ve görülebilirlik özelliği
- Aşağı ve Yukarı yön için ayrı gong uyarı sesleri
- Gong ve çağrı kayıt ses tonu ve şiddeti ayarı.
- Kat geçiş animasyon seçeneği.
- Kat geçiş animasyon hızının ayarlanabilmesi sayesinde çok yüksek hızlı asansörlerde dahi sorunsuz çalışma özelliği.
- Seçilebilir ilave şalter girişi (VIP çağrı veya katta yangın girişi)

LCS-LCM Landing Operating Button Features

- Automated floor identification (addressing) feature
- Power saving feature with stand-by and sleep modes
- High visibility and fast readable with bright LED's
- Different Gong sound tones for each direction
- Adjustable sound level and tone for Gong and Call Registration Feedback
- Selectable floor counting animations
- With adjustable floor counting animation speed, working synchronous even with very high speed elevators.
- Selectable extra input (VIP call or fire input)

Kabin Butonyerleri

Car Operating Button Panels (Cops)

TAM BOY KUTULU KABİN BUTONYER MODELLERİ

Full Size Cabin Operating Button Panel Models / with box

CPL-H MODEL



Kabin Butonyerleri

Car Operating Button Panels (Cops)

TAM BOY SIVA ÜZERİ BUTONYER MODELLERİ
Full Size Cabin Operating Button Panel Models / Surface Mount

CPL-K MODEL



CP-L-K2



CP-L-K3



CP-L-K4

Kabin Butonyerleri

Car Operating Button Panels (Cops)

YATAY KABİN BUTONYER MODELİ

Horizontal Cabin Operating Button Panel Model

CPS-Y MODEL



KABİN BUTONYER İLAVELERİ

Car Button Options



Görsel UV baskılı plexiglass
Visual UV printed plexiglass



UV Baskılı Ayd. Logo
UV Print Logo w/Light



Telefon Yeri
Telephone Box



Kat Bilgi Etiketi
Floor Information Labels



Vatman Anahtarı
Preferential/Service Key



Şifre Cihazı (Tuşlu)
Password Device w/
Pushbuttons



Akbil Geçiş Sistemi
Access System w/Akbil
Reader



Kartlı Geçiş Sistemi
Access System w/Card
Reader

Kat Butonyerleri

Landing Operating Button Panel (LOPs)

VP Model Kat Butonyerleri
VL Model Kapı Yanı ve Kapı
Üzeri Göstergeler

VP MODEL LANDING OPERATING
BUTTON PANELS
VL MODEL OVERDOOR INDICATORS
AND HALL LANTERNS



VL-4103



VL-4201



VL-4203



VP-4100



VP-4200



VP-4101



VP-4201



VP-4103



VP-4203

YP Model Kat Butonyerleri
 YL Model Kapı Yanı ve Kapı Üzeri Göstergeler
 YP MODEL LANDING OPERATING BUTTON PANELS
 YL MODEL OVERDOOR INDICATORS AND HALL LANTERNS



YL-4103



YL-4201



YL-4203



YP-4100



YP-4200



YP-4101



YP-4201



YP-4103



YP-4203



Kat Butonyerleri

Landing Operating Button Panel (LOPs)

ZP ve ZD Model Kat Butonyerleri
ZL Model Kapı Yanı ve Kapı Üzeri Göstergeler

ZP AND ZD MODEL LANDING OPERATING BUTTON PANELS
ZL MODEL OVERDOOR INDICATORS AND HALL LANTERNS



ZL-4103



ZL-4201

ZL-4203



ZP-4100

ZP-4200

ZP-4101

ZP-4201

ZP-4103

ZP-4203



ZD-4101

ZD-4201

ZD-4103

ZD-4203



HL-4103



HL-4201



HL-4203

HP ve HD Model Kat Butonyerleri HL Model Kapı Yanı ve Kapı Üzeri Göstergeler

HP AND HD MODEL LANDING OPERATING BUTTON PANELS
HL MODEL OVERDOOR INDICATORS AND HALL LANTERNS



HP-4100



HP-4200



HP-4101



HP-4201



HP-4103



HP-4203



HD-4101



HD-4201



HD-4103



HD-4203

Kat Butonyerleri

Landing Operating Button Panel (LOPs)

KAT BUTONYER İLAVELER

Landing Operating Button Panel Options



İtfayeci Anahtarı
*Firemen Operation
Switch*



Işıklı Girilmez İşareti
No Entrance Sign w/Light



Şifre Cihazı ve Kart Okuyucu
*Password Device and
Card Reader*











Kart Okuyuculu Kat Kaseti
w/Card Reader



Kart Okuyuculu Kat Kaseti
LOP w/Card Reader

Kart Okuyucular

Card Reader

Ürün Kodu	Tip	Kapasite	Diğer Özellikler
 P 110	Proximity	2.000	120x56x18mm 12/24 V DC , Röle kuru kontak, zil
M 110	Mifare	2.000	120x56x18mm 12/24 V DC , Röle kuru kontak, zil
 P 111	Proximity	2.000	120x56x18mm 12/24 V DC , Röle kuru kontak
M 111	Mifare	2.000	120x56x18mm 12/24 V DC , Röle kuru kontak
 TEC YS502	Proximity	2.000	113x60x17mm ROLE 12V-24V DC Röle kuru kontak
 P 200	Proximity	1.000	120x76x28mm ROLE 12V-24V DC Röle kuru kontak, zil
 P 161	Proximity	800	Röle 12V DC Kuru Kontak 113x60x17xmm kart+zil+ışık
M 161	Mifare	800	Röle 12V DC Kuru Kontak 113x60x17xmm kart 6sn süre
 P 160	Proximity	800	Röle 12V DC Kuru Kontak 113x60x17xmm kart+zil+ışık
M 160	Mifare	800	Röle 12V DC Kuru Kontak 113x60x17xmm kart 6sn süre
 P 1010	Proximity	10.000	Röle 12V DC Kuru Kontak 120x78x22xmm kart okuyucu
 P 140	Proximity	1.000	Röle 12V DC Kuru Kontak120x78x22xmm kart,zil,ışık

Konsollar

Consols



S1 6*4 18 cm 5 mm



S2 6*6 18 cm 5 mm



S3 6*9 20 cm 5 mm



S4 6*12 20 cm 5 mm



Ayarlanabilir Ağırlık Konsolu L
Adjustable Weight Console LC



S7 6*20 20 cm 5 mm



S7 6*15 15 cm 5 mm

Asansör Rayları

Elevator Rails

ÇALIŞTIĞIMIZ MARKALAR

BRANDS WE WORK WITH

 **Savera**

 **MARAZZI**

 **MONTEFERRO**

 **ÖZRAY**
Asansör Ray Sistemleri
Elevator Rail Systems

TÜRKRAY
DEMİR SANAYİ TİC. LTD. ŞTİ.

 **TÜRKELİ RAY**

 **ASRAY**
ASANSÖR KILAVUZ RAYLARI

 **CELİKRAY**
ASANSÖR KILAVUZ RAYLARI
ELEVATOR GUIDE RAILS



45*45*5 Asansör Rayı

70*70*9 Asansör Rayı

50*50*5 Asansör Rayı

72*62*10 Asansör Rayı

65*56*9 Asansör Rayı

89*62*16 Asansör Rayı

70*65*9 Asansör Rayı

90*75*16 Asansör Rayı

Elevator Rails

Elevator Rails

Asansör Yedek Parçaları

Elevator Spare Parts



Cold Drawn Guide Rails

Rail De Guidage D'Ascenseur

Холоднокатаный направляющие рельсы

السكك السحب الباردة

T50 / A - 50*50*5
T70 / A - 70*65*9
T82 / A - 82*68*9
T89 / A - 89*62*16
T90 / A - 90*75*16

Machined Guide Rails

Rails Forgé de Guide

Обработанные Направляющие рельсы

السكك المعمولة

T70 / B - 70*65*9
T75 / B - 75*62*10
T89 / B - 89*62*16
T90 / B - 90*75*16
T114 / B - 114*89*16
T125 / B - 125*82*16
T127-2 / B - 127*89*16



Bracets / Equerre De Fixation / Кронштейны / المفاصل

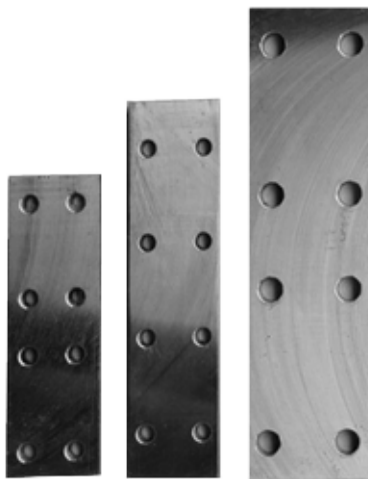

Fishplates / Joint / Прижимы / قطع الوصل



Guide Rail Nails / Clips / Сытыковочные планки / أطراف السكك

Asansör Yedek Parçaları

Elevator Spare Parts



Asansör Yedek Parçaları

Elevator Spare Parts



Asansör Yedek Parçaları

Elevator Spare Parts



Asansör Yedek Parçaları

Elevator Spare Parts



BEKASIA
E L E V A T O R

MAKİNELER

Machines



Makineler - Dişlisiz

Machines - Gearless

EMF Motor®



SQML 100



SQML 132



SQML 160



SQML 200

Makineler - Dişlilil

Machines - Geared

eker
Büyük Eker Bijon Sanayi ve Ticaret A.Ş.



SMART



STRONG LITE



STRONG PLUS



STRONG

Makineler - Dişlisiz

Machines - Gearless



QS-1



QS-2



QS-4



QS-5



QS-3



QS-6

Makineler - Dişli

Machines - Geared



AKAR - DAK 80 TAMBURLU



AKAR - DAK 80



AKAR - DAK 135



AKAR - DAK 170



AKAR - DAK 190

Makineler - Dişlisiz

Machines - Gearless



AKAR - SMT 140AC



AKAR - SMT 200AC



AKAR - SMT 225AC



AKAR - SMT 250AC

Makineler - Dişlisiz

Machines - Gearless



Ak2



Ak3



Ak4



Ak5

Makineler - Dişli

Machines - Geared



ZF-82 YAN YATAKLI



ZF-102 YAN YATAKLI



ZF-60 YAN YATAKLI



ZF-112 YAN YATAKLI

IMODERN
İYENİLİKÇİ

BEKASIA
E L E V A T O R

2021

Catalogue / Katalođu

Güvenliđiniz Emin Ellerde...